



Universal Temperature Converter

KFD2-UT2-Ex2

- 2-channel isolated barrier
- 24 V DC supply (Power Rail)
- Thermocouple, RTD, potentiometer or voltage input
- Usable as signal splitter (1 input and 2 outputs)
- Current output 0/4 mA ... 20 mA
- Sink or source mode
- Configurable by PACTware
- Line fault (LFD) and sensor burnout detection
- Up to SIL 2 acc. to IEC/EN 61508 / IEC/EN 61511



Function

This isolated barrier is used for intrinsic safety applications. The device converts the signal of a resistance thermometer, thermocouple, or potentiometer to a proportional output current. The device can also be configured as a signal splitter. The removable terminal block K-CJC-** is available as an accessory for internal cold junction compensation of thermocouples. A fault is signaled by LEDs acc. to NAMUR NE44 and a separate collective error message output. The device is easily configured by the use of the PACTware configuration software. For additional information, refer to the manual and www.pepperl-fuchs.com.

Connection

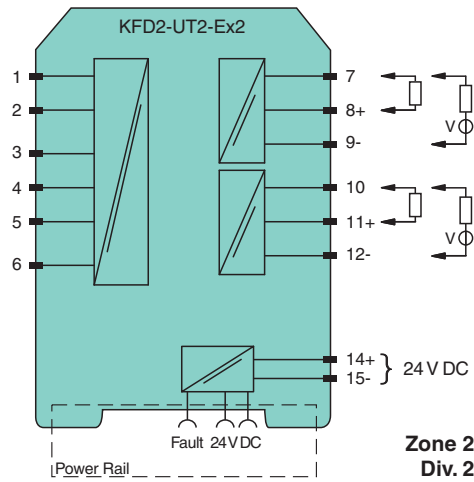
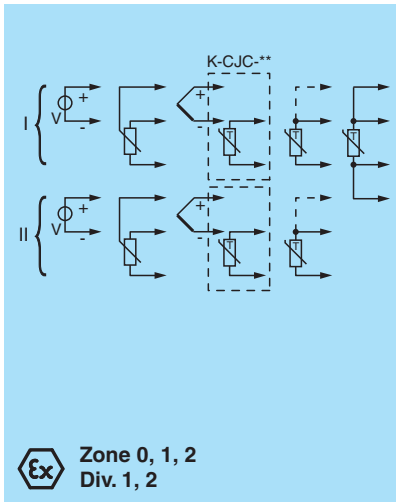

Technical Data

General specifications	
Signal type	Analog input
Functional safety related parameters	
Safety Integrity Level (SIL)	SIL 2
Supply	
Connection	terminals 14+, 15- or power feed module/Power Rail
Rated voltage	U_r 20 ... 30 V DC
Ripple	within the supply tolerance
Power dissipation	≤ 1.53 W
Power consumption	max. 1.53 W

Release date: 2023-01-03 Date of issue: 2023-01-03 Filename: 70157029_eng.pdf

Technical Data

Interface	
Programming interface	programming socket
Input	
Connection side	field side
Connection	terminals 1, 2, 3; 4, 5, 6
RTD	type Pt10, Pt50, Pt100, Pt500, Pt1000 (EN 60751: 1995) type Pt10GOST, Pt50GOST, Pt100GOST, Pt500GOST, Pt1000GOST (6651-94) type Cu10, Cu50, Cu100 (P50353-92) type Ni100 (DIN 43760)
Measuring current	approx. 200 µA with RTD
Types of measuring	2-, 3-wire connection
Lead resistance	max. 50 Ω per line
Measurement loop monitoring	sensor breakage, sensor short-circuit
Thermocouples	type B, E, J, K, N, R, S, T (IEC 584-1: 1995) type L (DIN 43710: 1985) type TXK, TXKH, TXA (P8.585-2001)
Cold junction compensation	external and internal
Measurement loop monitoring	sensor breakage
Potentiometer	0 ... 20 kΩ (2-wire connection), 0.8 ... 20 kΩ (3-wire connection)
Voltage	selectable within the range -100 ... 100 mV
Input resistance	≥ 1 MΩ (-100 ... 100 mV)
Output	
Connection side	control side
Connection	output I: terminal 7: source (-), sink (+), terminal 8: source (+), terminal 9: sink(-) output II: terminal 10: source (-), sink (+), terminal 11: source (+), terminal 12: sink(-)
Output I, II	Analog current output
Current range	0 ... 20 mA or 4 ... 20 mA
Fault signal	downscale 0 or 2 mA, upscale 21.5 mA (acc. NAMUR NE43)
Source	load 0 ... 550 Ω open-circuit voltage ≤ 18 V
Sink	Voltage across terminals 5 ... 30 V. If the current is supplied from a source > 16.5 V, series resistance of $\geq (V - 16.5)/0.0215 \Omega$ is needed, where V is the source voltage. The maximum value of the resistance is $(V - 5)/0.0215 \Omega$.
Transfer characteristics	
Deviation	
After calibration	Pt100: $\pm (0.06 \%$ of measurement value in K + 0.1 % of span + 0.1 K (4-wire connection)) thermocouple: $\pm (0.05 \%$ of measurement value in °C + 0.1 % of span + 1 K (1.2 K for types R and S)), includes ± 0.8 K fault of the cold junction compensation (CJC) mV: $\pm (50 \mu\text{V} + 0.1 \%$ of span) potentiometer: $\pm (0.05 \%$ of full scale + 0.1 % of span, (excludes faults due to lead resistance))
Influence of ambient temperature	Pt100: $\pm (0.0015 \%$ of measurement value in K + 0.006 % of span)/K $\Delta T_{\text{amb}}^{1)}$ thermocouple: $\pm (0.02 \text{ K} + 0.005 \%$ of measurement value in °C + 0.006 % of span)/K $\Delta T_{\text{amb}}^{1)}$, influence of cold junction compensation (CJC) included mV: $\pm (0.01 \%$ of measurement value + 0.006 % of span)/K $\Delta T_{\text{amb}}^{1)}$ potentiometer: $\pm 0.006 \%$ of span/K $\Delta T_{\text{amb}}^{1)}$ ¹⁾ ΔT_{amb} = ambient temperature change referenced to 23 °C (296 K)
Influence of supply voltage	< 0.01 % of span
Influence of load	≤ 0.001 % of output value per 100 Ω
Reaction time	worst case value (sensor breakage and/or sensor short circuit detection enabled) mV: 1.2 s, thermocouples with CJC: 1.4 s, thermocouples with fixed ref. temp: 1.4 s, 3- or 4-wire RTD: 1.1 s, 2-wire RTD: 920 ms, Potentiometer: 3-wire connection 2.8 s, 2-wire connection 2.25 s
Galvanic isolation	
Output/supply, programming input	functional insulation, rated insulation voltage 50 V AC There is no electrical isolation between the programming input and the supply. The programming cable provides galvanic isolation so that ground loops are avoided.
Indicators/settings	
Display elements	LEDs
Configuration	via PACTware
Labeling	space for labeling at the front
Directive conformity	

Release date: 2023-01-03 Date of issue: 2023-01-03 Filename: 70157029_eng.pdf

Technical Data







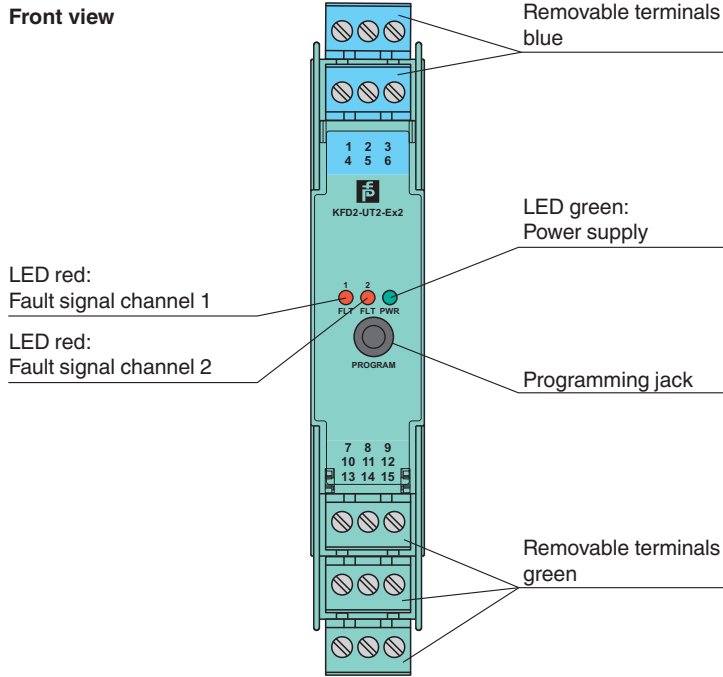

Electromagnetic compatibility		
Directive 2014/30/EU		EN 61326-1:2013 (industrial locations)
Conformity		
Electromagnetic compatibility		NE 21:2006
Degree of protection		IEC 60529:2001
Protection against electrical shock		UL 61010-1:2004
Ambient conditions		
Ambient temperature		-20 ... 60 °C (-4 ... 140 °F)
Mechanical specifications		
Degree of protection		IP20
Connection		screw terminals
Mass		approx. 130 g
Dimensions		20 x 119 x 115 mm (0.8 x 4.7 x 4.5 inch) (W x H x D) , housing type B2
Mounting		on 35 mm DIN mounting rail acc. to EN 60715:2001
Data for application in connection with hazardous areas		
EU-type examination certificate		CESI 04 ATEX 143
Marking		⊕ II (1)G [Ex ia Ga] IIC ⊕ II (1)D [Ex ia Da] IIIC ⊕ I (M1) [Ex ia Ma] I
Input		Ex ia
Inputs		terminals 1, 2, 3, 4, 5, 6 (for passive equipment)
Voltage U_o		9 V
Current I_o		22 mA
Power P_o		50 mW
Analog outputs, power supply, collective error		
Maximum safe voltage	U_m	250 V (Attention! This is not the rated voltage.)
Interface		
Maximum safe voltage	U_m	250 V (Attention! The rated voltage is lower.), RS 232
Certificate		
Marking		⊕ II 3G Ex nA II T4
Galvanic isolation		
Input/Other circuits		safe electrical isolation acc. to IEC/EN 60079-11, voltage peak value 375 V
Directive conformity		
Directive 2014/34/EU		EN 60079-0:2012+A11:2013 , EN 60079-11:2012 , EN 60079-15:2010 , EN 50303:2000
International approvals		
UL approval		
Control drawing		116-0410
CSA approval		
Control drawing		116-0314 (cCSAus) 116-0347
IECEx approval		
IECEx certificate		IECEx TUN 07.0003 IECEx CML 16.0126X
IECEx marking		[Ex ia Ga] IIC [Ex ia Da] IIIC [Ex ia Ma] I Ex nA IIC T4 Gc
General information		
Supplementary information		Observe the certificates, declarations of conformity, instruction manuals, and manuals where applicable. For information see www.pepperl-fuchs.com .

Release date: 2023-01-03 Date of issue: 2023-01-03 Filename: 70157029_eng.pdf

Assembly



Matching System Components





	DTM Interface Technology	Device type manager (DTM) for interface technology
	PACTware 5.0	FDT Framework
	K-ADP-USB	Programming adapter with USB interface
	KFD2-EB2	Power Feed Module
	UPR-03	Universal Power Rail with end caps and cover, 3 conductors, length: 2 m
	UPR-03-M	Universal Power Rail with end caps and cover, 3 conductors, length: 1,6 m
	UPR-03-S	Universal Power Rail with end caps and cover, 3 conductors, length: 0.8 m
	K-DUCT-BU	Profile rail, wiring comb field side, blue
	K-DUCT-BU-UPR-03	Profile rail with UPR-03- * insert, 3 conductors, wiring comb field side, blue

Accessories

	K-250R	Measuring resistor
---	---------------	--------------------

Release date: 2023-01-03 Date of issue: 2023-01-03 Filename: 70157029_eng.pdf

Accessories

	K-500R0%1	Measuring resistor
	K-CJC-BU	Terminal block for cold junction compensation, 3-pin screw terminal, blue
	KF-ST-5GN	Terminal block for KF modules, 3-pin screw terminal, green
	KF-ST-5BU	Terminal block for KF modules, 3-pin screw terminal, blue
	KF-CP	Red coding pins, packaging unit: 20 x 6