

Connection cable, Ethernet V1SD-W-GN10M-PUR-E2S-V45-G

- Hard-wearing PUR cable
- Suitable for drag chains and abrasion resistant
- D coding for Ethernet
- CAT5/CAT5e cable
- Degree of protection IP68 / IP69
- Free of paint wetting interfering substances
- UV resistant
- Halogen-free
- Specific design protects against loosening and inaccurate installation

Ethernet bus cable M12 plug angled D-coded to RJ45 Ethernet-coded, 4-pin, PUR cable green, Cat5e, shielded



Dimensions

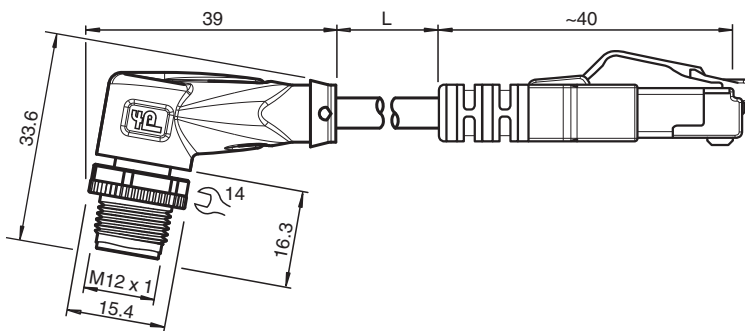

Technical Data

General specifications

Connector 1		
Connection		plug
Construction type		M12
Style		angled
Locking		screw connection
Number of pins		4
Coding		D-coded
Connector 2		
Connection		plug
Construction type		RJ45
Style		straight
Locking		snap locking
Number of pins		8
Coding		EtherNet/IP

Electrical specifications

Operating voltage	U_B	max. 48 V AC / 60 V DC
Operating current	I_B	max. 1 A

Conformity

Degree of protection		EN 60529
----------------------	--	----------

Release date: 2025-02-26 Date of issue: 2025-02-26 Filename: 70164939_eng.pdf

Technical Data

Plug connection		connector M12 x 1 : IEC 61076-2-101 connector RJ45 : IEC 60603-7
Component category		CAT5 (IEC 11801) , CAT5e (IEC 61156-6)
Flammability		IEC 60332-1-2 / UL 1581 / ISO 6722-1 5.22 (UN ECE-R 118.01)
Halogen-free		IEC 60754-1
Chemical resistance		DIN EN 60811-2-1
UV resistance		UL 1581 section 1200
Microbial resistance		DIN EN 50525-2-21 / DIN VDE 0282-10
Oil resistance		DIN EN 60811-2-1
Ambient conditions		
Ambient temperature		
Connector 1		-40 ... 90 °C (-40 ... 194 °F)
Cable, fixed installation		-40 ... 80 °C (-40 ... 176 °F)
Cable, flexing		-30 ... 70 °C (-22 ... 158 °F)
Mechanical specifications		
Connector 1		
Tightening torque		0.6 Nm
Loosening protection		integrated
Tool installation		straight knurling and hexagon nut SW = 14 mm
Mating cycles		min. 100
Shielding		shield connected to screw connection
Degree of protection		IP68 / IP69
Connector 2		
Loosening protection		integrated
Mating cycles		min. 100
Shielding		shield connected to connector
Degree of protection		IP20
Cable		according to IEC/EN 60228 (DIN VDE 0295) class 5
Sheath diameter		4.9 mm
Bending radius		> 12 x cable diameter, movable installation > 6 x cable diameter, fixed installation
Sheath stripping force		max. 50 N / 100 mm
Sheath color		green (similar to RAL 6018)
Number of cores		4
Core cross section		0.15 mm ² / 26 AWG
Cores color		Core 1-1: white/orange Core 2-3: white/green Core 3-2: orange Core 4-6: green
Core construction		19 x 0.1 mm Ø twisted quad
Shield		aluminum-lined polyester foil Tinned copper braiding, 85 % coverage
Length	L	10 m
Cable code		Li 9Y 11YM 4 x 0,15
Drag chain suitability		
Drag chain cycles		max. 1000000
Motion velocity		max. 3 m/s
Traverse distance		max. 4.5 m
Acceleration		max. 3 m/s ²
Mass		329.3 g
Material		
PWIS free		yes
Halogen-free		yes
Connector 1		
Screw connection		Zinc diecast, nickel-plated

Release date: 2025-02-26 Date of issue: 2025-02-26 Filename: 70164939_eng.pdf

Technical Data

Body	TPU, black
Contact surface	Au
Flammability	V-2
Connector 2	
Body	PA, green
Flammability	V-0
Cable	
Sheathing	PUR based on polyether
Cores	bare copper (Cu)
Core insulation	PP
UV resistance	yes
Oil resistance	yes
Microbial resistance	yes
Flammability	FT1 complies with UN ECE-R 118.01

Connection Assignment

