

Cable connector, Ethernet

V1SD-W-GN2M-PUR-E2S



- Hard-wearing PUR cable
- Suitable for drag chains and abrasion resistant
- D coding for Ethernet
- CAT5/CAT5e cable
- Degree of protection IP68 / IP69
- Free of paint wetting interfering substances
- UV resistant
- UL listed for USA and Canada
- Halogen-free
- Specific design protects against loosening and inaccurate installation

Ethernet bus cable male cordset single-ended M12 angled D-coded 4-pin, PUR cable green, Cat5e, shielded, UL approved



Dimensions

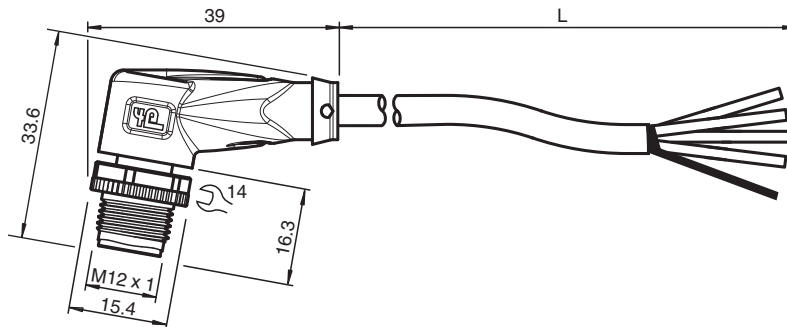

Technical Data

General specifications

Connector 1	
Connection	plug
Construction type	M12
Style	angled
Locking	screw connection
Number of pins	4
Coding	D-coded
Connector 2	
Connection	cable end

Electrical specifications

Operating voltage	U_B	max. 250 V AC/DC
Operating current	I_B	max. 4 A

Conformity

Degree of protection	EN 60529
Plug connection	connector M12 x 1 : IEC 61076-2-101
Component category	CAT5 (IEC 11801) , CAT5e (IEC 61156-6)
Flammability	IEC 60332-1-2 / UL 1581 / ISO 6722-1 5.22 (UN ECE-R 118.01)
Halogen-free	IEC 60754-1

Release date: 2025-02-26 Date of issue: 2025-02-26 Filename: 70164940_eng.pdf

Technical Data

Chemical resistance		DIN EN 60811-2-1
UV resistance		UL 1581 section 1200
Microbial resistance		DIN EN 50525-2-21 / DIN VDE 0282-10
Oil resistance		DIN EN 60811-2-1
Approvals and certificates		
UL approval		AWM STYLE 21161 AWM I/II A/B 80°C 300V FT1 (cable)
UL File Number		E231213
Ambient conditions		
Ambient temperature		
Plug connector		-40 ... 90 °C (-40 ... 194 °F)
Cable, fixed installation		-40 ... 80 °C (-40 ... 176 °F)
Cable, flexing		-30 ... 70 °C (-22 ... 158 °F)
Mechanical specifications		
Plug connector		
Tightening torque		0.6 Nm
Loosening protection		integrated
Tool installation		straight knurling and hexagon nut SW = 14 mm
Mating cycles		min. 100
Shielding		shield connected to screw connection
Degree of protection		IP68 / IP69
Cable		
Sheath diameter		4.9 mm
Bending radius		> 12 x cable diameter, movable installation > 6 x cable diameter, fixed installation
Sheath stripping force		max. 50 N / 100 mm
Sheath color		green (similar to RAL 6018)
Number of cores		4
Core cross section		0.15 mm ² / 26 AWG
Cores color		Core 1: white/orange Core 2: white/green Core 3: orange Core 4: green
Core construction		19 x 0.1 mm Ø twisted quad
Shield		aluminum-lined polyester foil Tinned copper braiding, 85 % coverage
Length	L	2 m
Cable code		Li 9Y 11YM 4 x 0,15
Drag chain suitability		
Drag chain cycles		max. 1000000
Motion velocity		max. 3 m/s
Traverse distance		max. 4.5 m
Acceleration		max. 3 m/s ²
Mass		78 g
Material		
PWIS free		yes
Halogen-free		yes
Plug connector		
Screw connection		Zinc diecast, nickel-plated
Body		TPU, black
Contact surface		Au
Flammability		V-2
Cable		
Sheathing		PUR based on polyether
Cores		bare copper (Cu)

Release date: 2025-02-26 Date of issue: 2025-02-26 Filename: 70164940_eng.pdf

Technical Data

Core insulation	PP
UV resistance	yes
Oil resistance	yes
Microbial resistance	yes
Flammability	FT1 complies with UN ECE-R 118.01

Connection Assignment

