

Y connection cable

V1S/V1-YE0,15-PUR-A1-TEE-0,3-V1



- Easy merging of two signals at a single M12 slot
- Improved resistance to weld slag
- Suitable for drag chains and abrasion resistant
- Suitable for robotic applications / torsion resistant
- Degree of protection IP68 / IP69
- Free of paint wetting interfering substances
- Resistant to microbes and hydrolysis
- UL listed for USA and Canada
- Halogen-free
- Specific design protects against loosening and inaccurate installation
- Image is generic for this device type and may deviate from the specific variant

Y connection cable M12 socket straight A-coded to M12 plug / M12 socket straight A-coded, 4-pin, 3x PUR cable welding-bead resistant yellow, UL approved, drag chain suitable, torsion resistant



Dimensions

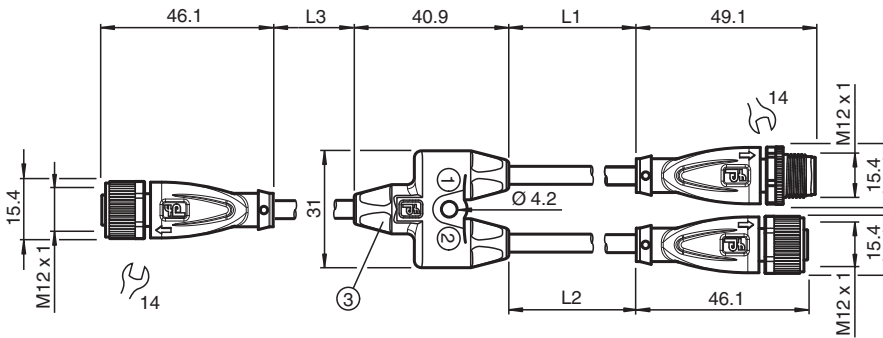

Technical Data

General specifications

Connector 1	
Connection	plug
Construction type	M12
Style	straight
Locking	screw connection
Number of pins	4
Coding	A-coded
Connector 2	
Connection	socket
Construction type	M12
Style	straight
Locking	screw connection
Number of pins	4
Coding	A-coded
Connector 3	
Connection	socket
Construction type	M12

Release date: 2023-10-09 Date of issue: 2023-10-09 Filename: 70168847_eng.pdf

Technical Data

Style		straight
Locking		screw connection
Number of pins		4
Coding		A-coded
Electrical specifications		
Operating voltage	U_B	max. 48 V AC / 60 V DC
Operating current	I_B	max. 4 A
Conformity		
Degree of protection		EN 60529
Plug connection		connector M12 x 1 : IEC 61076-2-101
Flammability		UL 1581; DIN EN 60332-2-2
Halogen-free		DIN VDE 0472-815
Microbial resistance		DIN EN 50525-2-21 / DIN VDE 0282-10
Hydrolysis resistance		DIN EN 50525-2-21
Approvals and certificates		
UL approval		AWM STYLE 20549 AWM I/II A/B 80°C 300V FT2 (cable)
Maximum permissible operating voltage		max. 30 V AC/DC
UL File Number		E231213
Ambient conditions		
Ambient temperature		
Plug connector		-40 ... 90 °C (-40 ... 194 °F)
Cable, fixed		-40 ... 80 °C (-40 ... 176 °F)
Cable, flexing		-25 ... 80 °C (-13 ... 176 °F)
Pollution degree		3
Mechanical specifications		
Plug connector		
Tightening torque		0.6 Nm
Loosening protection		available
Tool installation		straight knurling and hexagon nut SW = 14 mm
Mating cycles		min. 100
Degree of protection		IP68 / IP69
Cable		according to IEC/EN 60228 (DIN VDE 0295) class 6
Sheath diameter		5.3 mm
Bending radius		> 10 x cable diameter, moving > 5 x cable diameter, fixed
Sheath stripping force		max. 80 N / 300 mm
Sheath color		yellow (similar to RAL 1021)
Number of cores		5
Core cross section		0.34 mm ²
Cores color		Core 1: brown Core 2: white Core 3: blue Core 4: black Core 5: not used
Core construction		42 x 0.1 mm Ø
Length	L	L1 = 0.15 m L2 = 0.15 m L3 = 0.3 m
Cable code		Li F 9Y 11Y 5 x 0,34
Drag chain suitability		
Drag chain cycles		min. 5000000
Motion velocity		max. 3 m/s
Traverse distance		max. 5 m
Acceleration		max. 5 m/s ²
Torsion cycles		min. 1000000
Torsional stress		± 180 °/m

Release date: 2023-10-09 Date of issue: 2023-10-09 Filename: 70168847_eng.pdf





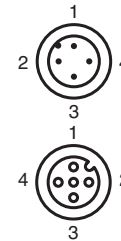
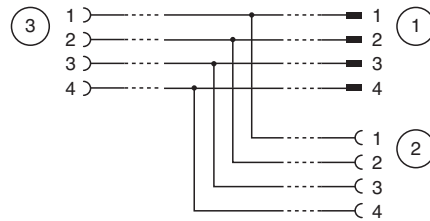
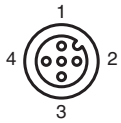

Technical Data

Material	
PWIS free	yes
Halogen-free	yes
Plug connector	
Screw connection	Zinc diecast, nickel-plated
Body	TPU, black
Seal	FKM
Contact surface	gold plated (Au)
Flammability	V-2
Cable	
Sheathing	PUR based on polyether
Core insulation	PP
Welding-bead resistance	yes
Weld spatter resistance	yes
Chemical resistance	good
Oil resistance	yes
Cooling lubricant resistance	yes
Microbial resistance	yes
Hydrolysis resistance	yes
Flammability	FT2

Connection Assignment



Accessories

	MH V1-SCREWDRIVER	Torque screwdriver (0.6 Nm)
	MH V1-BIT M12	plug-in cap M12
	V1/V3-LABELHOLDER	Label holder
	V1/V3-LABEL	Label plate
	MH V1-Holder	Modular universal holder for M12 connectors
	V1-CLIP	Unlocking protector for M12 connector
	V1-MARKING-RING-COLOR	Marking rings for M12 connectors, various colors