

Mounting set MHV-BT-F07

- Simple mounting
- All-in-one stainless steel solution
- Conforming to standards
- Adjustable in height

Adjustable assembly set for sizes F07 manual operated valves according to EN ISO5211 (without drive screw)

Dimensions

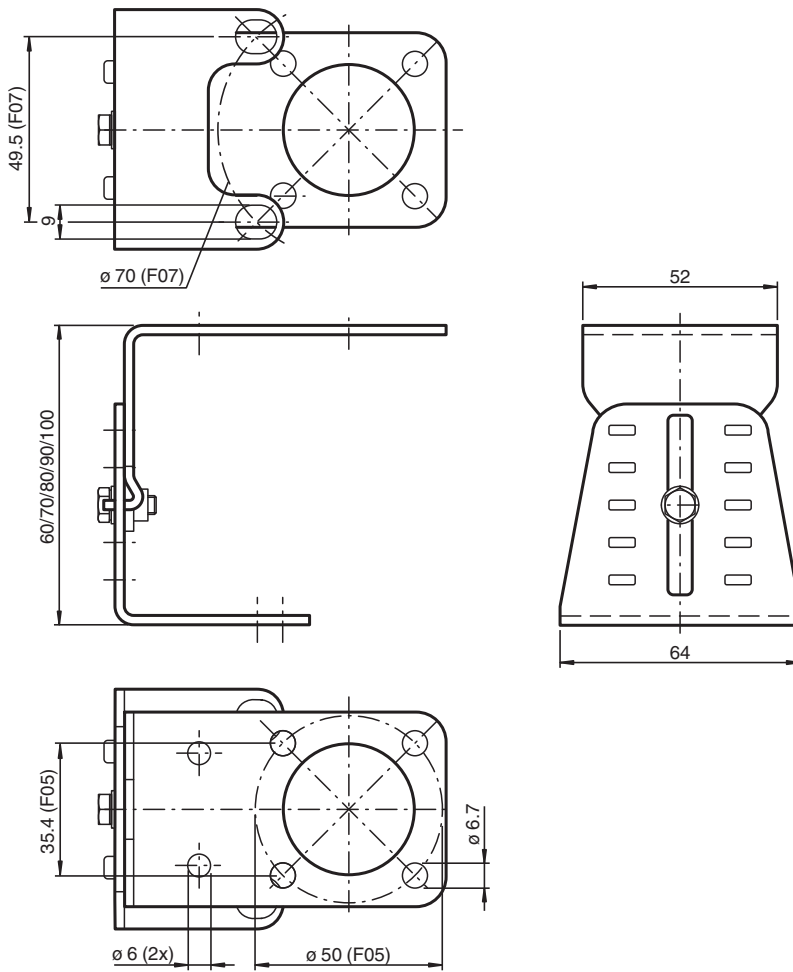

Technical Data

General specifications

Technical Data

Suitable sensors and	Dual sensors, -F25 series with actuator BT32... Dual sensors, -F25K series with actuator BT32... Dual sensors, -F31 series with actuator BT65... Dual sensors, -F31K series with actuator BT65... Dual sensors, -F31K2 series with actuator BT65...
Standard conformity	
Standards	DIN EN ISO 5211 / DIN 3337
Mechanical specifications	
Material	stainless steel 1.4301 / AISI 304 for plates and sheet metal bending parts
Mass	224 g
Dimensions	
Width	64 mm
Length	312 mm
General information	
Note	For the mounting set, an adapter plate and depending on this, and further accessories must be ordered.