

Y connection cable

DT2S/DT2S-G-2M-PUR-O1-T-DT4S-G

- Suitable for outdoor use (UV- and ozone resistant)
- Suitable for drag chains and abrasion resistant
- Degree of protection IP68
- Resistant to microbes and hydrolysis
- Oil resistant
- Resistant to salt water
- Halogen-free
- Snap locking

Y connection cable Deutsch socket straight 4-pin to 2x Deutsch socket straight 2-pin, 2x PUR cable black, drag chain suitable



Dimensions

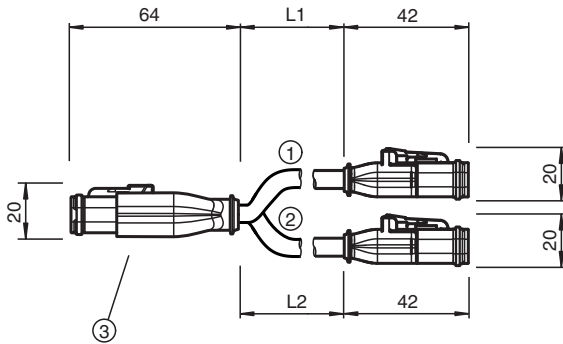

Technical Data

General specifications

Connector 1		
Connection		socket
Construction type		Deutsch connectors
Style		straight
Locking		snap locking
Number of pins		2
Connector 2		
Connection		socket
Construction type		Deutsch connectors
Style		straight
Locking		snap locking
Number of pins		2
Connector 3		
Connection		socket
Construction type		Deutsch connectors
Style		straight
Locking		snap locking
Number of pins		4
Electrical specifications		
Operating voltage	U _B	max. 48 V AC / 60 V DC

Release date: 2024-04-10 Date of issue: 2024-04-10 Filename: 70176338_eng.pdf

Technical Data

Operating current	I _B	max. 4 A
Conformity		
Degree of protection		EN 60529
Flammability		UL 1581; DIN EN 60332-2-2
Halogen-free		DIN VDE 0472-815 / DIN EN 50267-2-1
Oil resistance		DIN EN 60811-2-1
Ambient conditions		
Ambient temperature		
Plug connector		-40 ... 125 °C (-40 ... 257 °F)
Cable, fixed		-50 ... 105 °C (-58 ... 221 °F)
Cable, flexing		-30 ... 105 °C (-22 ... 221 °F)
Pollution degree		3
Mechanical specifications		
Plug connector		
Loosening protection		available
Degree of protection		IP68
Cable		according to IEC/EN 60228 (DIN VDE 0295) class 6
Sheath diameter		4.5 mm
Bending radius		> 10 x cable diameter, moving > 8 x cable diameter, fixed
Sheath stripping force		max. 50 N / 300 mm
Sheath color		black (similar to RAL 7021)
Number of cores		3
Core cross section		0.5 mm ²
Cores color		Core 1: brown Core 2: blue Core 3: brown Core 4: blue
Core construction		28 x 0.15 mm Ø 1 x symmetrically twisted
Length	L	2 m
Cable code		Li 9Y 11Y 3 x 0,50
Drag chain suitability		
Drag chain cycles		min. 2000000
Motion velocity		max. 3 m/s
Traverse distance		max. 10 m
Acceleration		max. 10 m/s ²
Material		
Halogen-free		yes
Plug connector		
Body		PA, black
Contact surface		Ni
Flammability		V-0
Cable		
Sheathing		PUR based on polyether
Core insulation		PP
Salt water resistance		yes
UV resistance		yes
Chemical resistance		good
Oil resistance		yes
Cooling lubricant resistance		yes
Microbial resistance		yes
Hydrolysis resistance		yes
Flammability		FT2

Release date: 2024-04-10 Date of issue: 2024-04-10 Filename: 70176338_eng.pdf

Connection Assignment

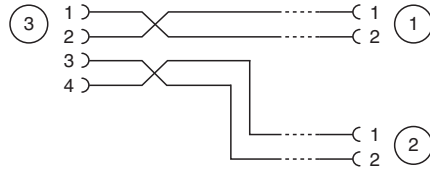

Release date: 2024-04-10 Date of issue: 2024-04-10 Filename: 70176338_eng.pdf