

Aluminum Enclosure Ex d IIB with flanged Cover

EJB2A.U.P.HL-S0001

- Copper-free aluminum enclosure
- Suitable for operation in Zone 1, Zone 2, Zone 21 and Zone 22
- Ex db and Ex tb certified
- Gas group IIB+H₂
- Degree of protection: IP 66



Dimensions

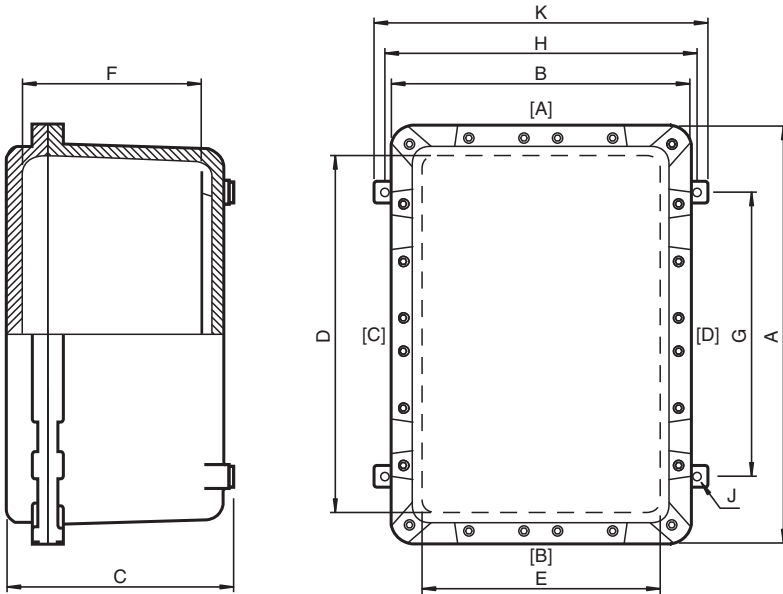

Dimension values see data table.
 Real values might differ slightly due to manufacturing tolerances.
 Dimensions are valid for standard enclosures and IP66 variants only.
 Image and drawing are generic for this device type and may deviate from the specific variant.

Legend	
A	Height
B	Width
C	Depth
D	Internal height
E	Internal width
F	Internal depth to surface mounting plate
G	Mounting holes distance, vertical
H	Mounting holes distance, horizontal
J	Mounting holes diameter
K	Maximum external dimension of mounting brackets
[A ... [D]	Cable entry faces

Release date: 2025-05-14 Date of issue: 2025-05-14 Filename: 70178109_eng.pdf

Technical Data

Electrical specifications	
Operating voltage	1500 V DC / 1000 V AC max. for ATEX / IECEx
Operating current	recommended: 1600 A max.
Mechanical specifications	
Thread type	metric ISO pitch 1.5 mm or NPT ANSI ASME B1.20.1
Enclosure cover	detachable , Hinge side left
Cover fixing	stainless steel socket cap head screws
Screws	M6
Number	8
Tightening torque	15 Nm
Material of screws	stainless steel
Yield stress	min. 450 N/mm ² for ATEX / IECEx
Cover seal	none
Flamepath grease	Greasil MS4 or NEVER SEEZ Marine Grade
Degree of protection	IP66
Cable entry face A	
M20 quantity	8
M25 quantity	8
M32 quantity	5
M42 quantity	3
M50 quantity	2
M63 quantity	1
Cable entry face B	
M20 quantity	8
M25 quantity	8
M32 quantity	5
M42 quantity	3
M50 quantity	2
M63 quantity	1
Cable entry face C	
M20 quantity	8
M25 quantity	8
M32 quantity	5
M42 quantity	3
M50 quantity	2
M63 quantity	1
Cable entry face D	
M20 quantity	8
M25 quantity	8
M32 quantity	5
M42 quantity	3
M50 quantity	2
M63 quantity	1
Cable entry enclosure cover	
M12 quantity	9
M20 quantity	9
M32 quantity	5
Cable entry enclosure bottom	
M20 quantity	2
M25 quantity	2
M32 quantity	2
Material	

Release date: 2025-05-14 Date of issue: 2025-05-14 Filename: 70178109_eng.pdf

Technical Data

Enclosure	aluminum alloy
Finish	epoxy coated RAL 7005 (grey)
Mounting plate	zinc plated mild steel
Mass	approx. 6.4 kg
Dimensions	values might differ slightly due to casting and manufacturing tolerances
External dimension (A)	223 mm
External dimension (B)	223 mm
External dimension (C)	170 mm
Internal dimension (D)	163 mm
Internal dimension (E)	163 mm
Internal dimension (F)	128 mm
Mounting holes distance (G)	157 mm
Mounting holes distance (H)	206 mm
Mounting holes diameter (J)	8 mm
Maximum external dimension (K)	226 mm
Mounting plate, thickness (MT)	2 mm
Grounding	M6 external grounding points
Ambient conditions	
Ambient temperature	-60 ... 180 °C (-76 ... 356 °F) depending on integrated components
Data for application in connection with hazardous areas	
EU-type examination certificate	INERIS 14 ATEX 9010U
Marking	⊕ II 2 GD Ex db IIB+H ₂ Gb Ex tb IIIC Db
Maximum power dissipation	104 W maximum power dissipation at T4/+40 °C enclosure without window
International approvals	
IECEx approval	IECEx INE 14.0028U
UKCA approval	CML 21 UKEX 1425U
Further approvals	available on request
Conformity	
Degree of protection	EN60529
CE marking	0080 or 0102, see type label
General information	
Ordering information	This solution will be delivered completely configured and assembled ready for use. For configuration details please contact Customer Service.
Supplementary information	EC-Type Examination Certificate, Statement of Conformity, Declaration of Conformity, Attestation of Conformity and instructions have to be observed where applicable. For information see www.pepperl-fuchs.com .