



Thru-beam sensor (pair) OBE10M-18GF60-S2PP-5M-IR



- Sensing range 10 m
- With increased sealing, degree of protection IP68
- Integrated circuit
- Narrow opening angle, suitable for mounting in pairs
- Not sensitive to ambient light
- DC voltage version
- Test input
- Reverse polarity protection
- Short-circuit protected
- Switching status indicator, yellow LED
- Fixed cable

Thru-beam sensor, M18 threaded housing design, plastic housing, 10 m detection range, infrared light, light/dark on, DC version, 2 push-pull outputs, fixed cable



Function

The optical sensor is optimized to perform in wet environments and in poor visibility conditions. To penetrate mist more effectively, the sensor uses multiple-beam infrared light.

With the full sealing, the sensor operates reliably in wet environments and over a wide temperature range.

Application

- Car wash machines
- Car parking systems
- Car access gates
- Monitoring of industrial gates
- Sawmill automation
- Bale presses / Channel presses
- Farm automation

Dimensions

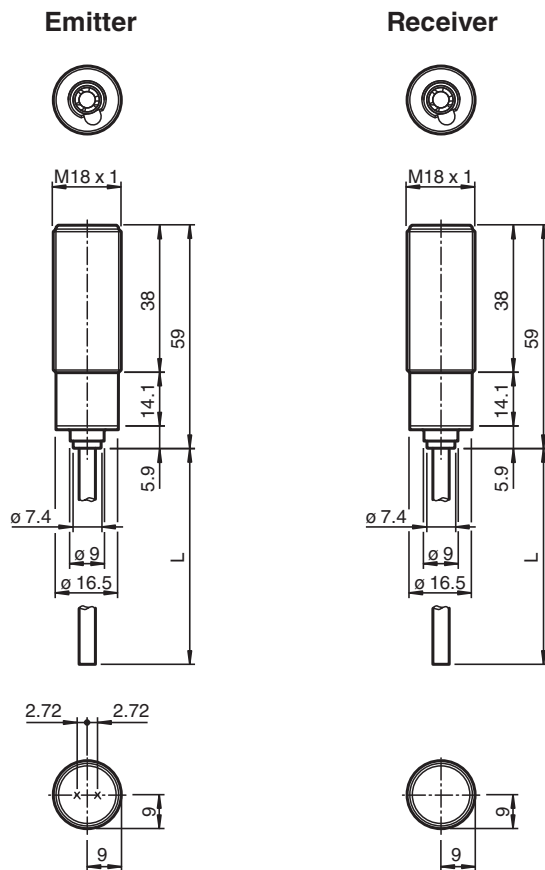

Technical Data

System components

Emitter	OBE10M-18GF60-S-5M-IR
Receiver	OBE10M-18GF60-2PP-5M-IR

General specifications

Effective detection range	0 ... 10 m
Threshold detection range	12 m
Light source	IRED
Light type	modulated infrared light , 850 nm
Diameter of the light spot	approx. 1500 mm at a distance of 10 m
Opening angle	Emitter: +/- 5 ° ; Receiver: +/- 10 °
Optical face	frontal
Ambient light limit	10000 Lux
Accessories provided	Mounting nuts

Functional safety related parameters

MTTF _d	606 a
Mission Time (T _M)	20 a
Diagnostic Coverage (DC)	0 %

Indicators/operating means

Operation indicator	Emitter: LED green: Power on
Function indicator	Receiver: LED yellow, lights up when light beam is free, flashes when falling short of the operating reserve ; OFF when light beam is interrupted

Electrical specifications

Technical Data

Operating voltage	U_B	10 ... 30 V DC
No-load supply current	I_0	Emitter: ≤ 17 mA Receiver: ≤ 13 mA
Protection class		Class III
Input		
Test input		emitter deactivation at 0 V
Output		
Switching type		dark-on and light-on
Signal output		2 push-pull (4 in 1) outputs, short-circuit protected, reverse polarity protected
Switching voltage		max. 30 V DC
Switching current		max. 100 mA
Voltage drop	U_d	≤ 1.5 V DC
Switching frequency	f	80 Hz
Response time		6 ms
Conformity		
Product standard		EN 60947-5-2
Approvals and certificates		
CE conformity		CE
UKCA conformity		UKCA
UL approval		E87056 , cULus Listed , class 2 power supply , type rating 1
CCC approval		CCC approval / marking not required for products rated ≤ 36 V
Ambient conditions		
Ambient temperature		-20 ... 60 °C (-4 ... 140 °F)
Storage temperature		-40 ... 70 °C (-40 ... 158 °F)
Relative humidity		90 % , noncondensing
Mechanical specifications		
Degree of protection		IP67 / IP68
Connection		fixed cable Receiver: grey ; Emitter: black
Material		
Housing		PC , black
Optical face		Plastic pane
Cable		
Length	L	5 m
Mass		approx. 230 g per device
Dimensions		
Length		59 mm
Diameter		18 mm
Thread size		M18

Connection

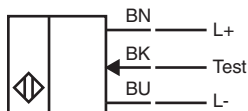

Connection

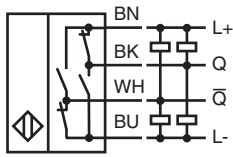

Indication

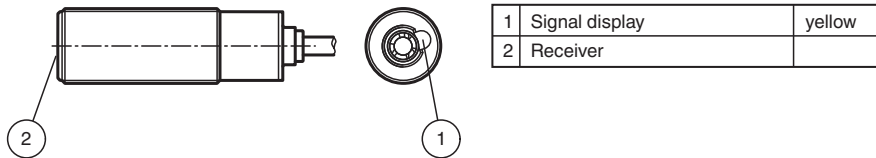
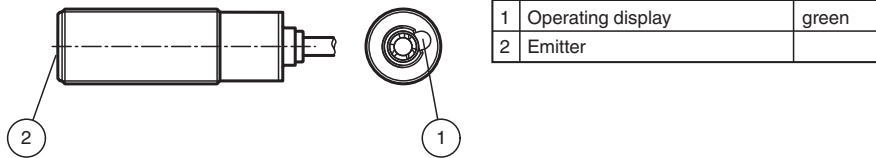

Installation

Mounting

Sensor: The sensors have an M18 x 1 threaded housing design and nuts. The sensors can be mounted directly through a simple Ø 18 mm hole, or using a mounting bracket. Mounting brackets are available as accessories. Pay careful attention to the position and visibility of the programming interface or signal indicators during mounting.

Apply the operating voltage to the sensor. The operating indicator lights up green. Mount the emitter and receiver opposite each other. Roughly align the emitter and receiver with each other. Next, adjust the sensor by swiveling it horizontally and vertically so that the yellow signal indicator lights up continuously. In the event of misalignment, the yellow signal indicator flashes.

Characteristic Curve

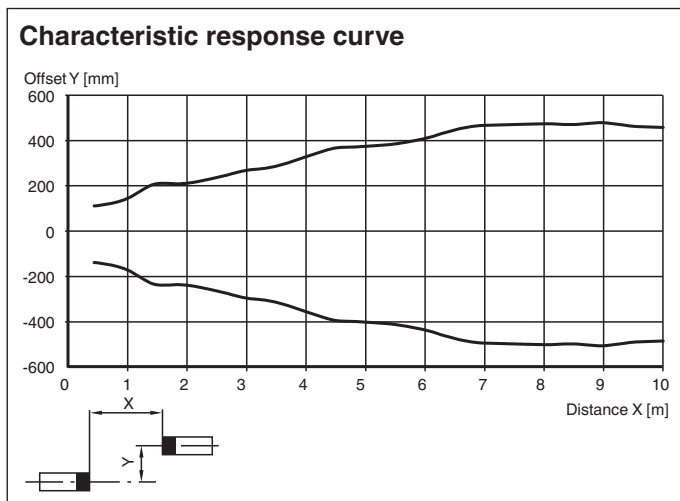

Release date: 2024-06-13 Date of issue: 2024-06-13 Filename: 70181228_eng.pdf

Characteristic Curve

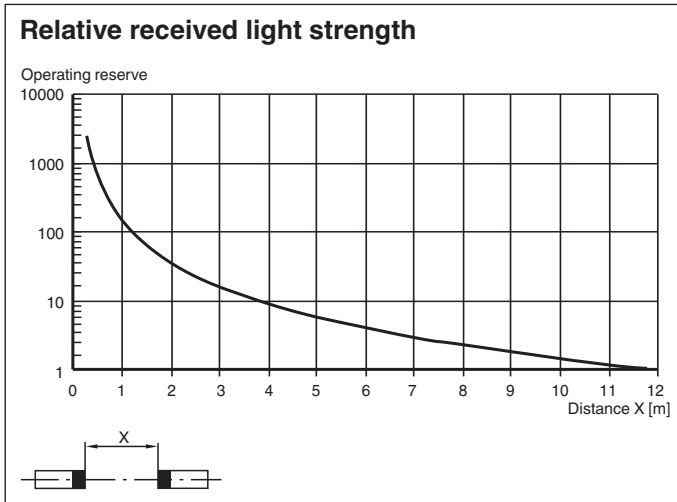

Safety Information

Prior to mounting, installation, and commissioning of the device you should make yourself familiar with the device and carefully read the instruction manual.

The personnel must be appropriately trained and qualified in order to carry out mounting, installation, commissioning, operation, maintenance, and dismantling of the device. The trained and qualified personnel must have read and understood the instruction manual.

The device is not a safety component according to the Machinery Directive. Do not use the device to prevent personal injury.

Function Principle

The thru-beam sensor requires two devices for operation; an emitter and a receiver. The emitter and receiver must be optically aligned with one another in a single line. The infrared light emitted from the emitter is recorded by the receiver and evaluated. The sensor detects both people and objects for as long as an object interrupts the detection beam, regardless of movement and surface structure.

Commissioning

Commissioning

Check Object Detection: Check as follows if the sensor detects objects as intended.

Position the object in the beam path of the sensor.

Once the object is detected, the yellow signal indicator goes out. As soon as the object leaves the beam path of the sensor, the yellow signal indicator permanently lights up again.

Configuration

Emitter Control Input

To vary the emitter range, connect the control input (black single core) to a grounded resistor of specific value:

External resistance at single core (BK) [Ω]	Emitter range [%]
0 (ground)	OFF (Test or synchronization applications)
Approx. 300	38
Approx. 500	55
Approx. 1000	72
Approx. 2000	86
Approx. 4000	96
Disconnected	100

Maintenance

Maintenance

Cleaning: If the transmission reception deteriorates, e.g., due to dirt, the yellow signal indicator on the receiver flashes. Clean the optical interfaces of the sensor (e.g., lenses) at regular intervals.

Maintenance: Check the mounting fittings and the electrical connections regularly.