



Thru-beam sensor (pair) OBE25M-18GK40-SE1-V1



- Short design in M18 plastic housing
- Not sensitive to ambient light
- Degree of protection IP67
- Very high detection range



Function

The optical sensors of this series have an M18 threaded housing that is optionally available in plastic or metal. The sensors are robust and versatile. Focusing on the essential requirements simplifies selection and commissioning, saving time and costs.

Dimensions

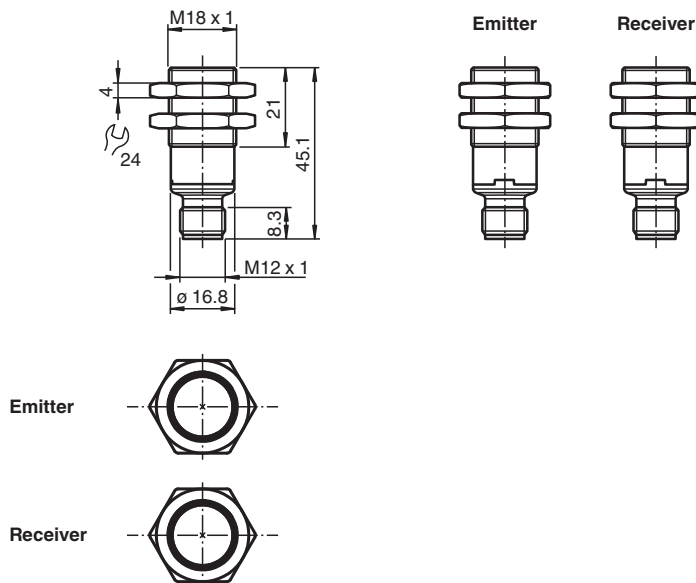

Technical Data

System components

Emitter	OBE25M-18GK40-S-V1
Receiver	OBE25M-18GK40-E1-V1

General specifications

Effective detection range	0 ... 25 m
---------------------------	------------

Technical Data

Threshold detection range		35 m
Light source		LED
Light type		modulated visible red light
Diameter of the light spot		approx. 110 mm at 1 m
Opening angle		approx. 2.9 °
Optical face		frontal
Ambient light limit		EN 60947-5-2 10000 Lux
Functional safety related parameters		
MTTF _d		838 a
Mission Time (T _M)		20 a
Diagnostic Coverage (DC)		0 %
Indicators/operating means		
Operation indicator		LED green: on - power on flashing (4 Hz) - short circuit
Function indicator		Receiver: Yellow LED: Permanently lit - light path clear Permanently off - object detected Flashing (4 Hz) - insufficient operating reserve
Electrical specifications		
Operating voltage	U _B	10 ... 30 V DC
Ripple		max. 10 %
No-load supply current	I ₀	< 25 mA
Protection class		III
Output		
Switching type		Q - Pin4: NPN normally closed / light-on
Signal output		1 NPN output, short-circuit protected, reverse polarity protected, open collector
Switching voltage		max. 30 V DC
Switching current		max. 100 mA , resistive load
Voltage drop	U _d	≤ 1.5 V DC
Switching frequency	f	500 Hz
Response time		≤ 1 ms
Conformity		
Product standard		EN 60947-5-2
Approvals and certificates		
UL approval		E87056 , cULus Listed , class 2 power supply , type rating 1
Ambient conditions		
Ambient temperature		-40 ... 60 °C (-40 ... 140 °F)
Storage temperature		-40 ... 70 °C (-40 ... 158 °F)
Mechanical specifications		
Degree of protection		IP67
Connection		3-pin, M12 x 1 connector
Material		
Housing		PC (Polycarbonate)
Optical face		PMMA
Connector		Plastic
Mass		approx. 8 g per device
Dimensions		
Length		45.1 mm
Diameter		18 mm
Thread size		M18

Connection Assignment

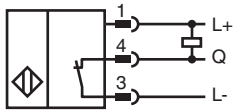
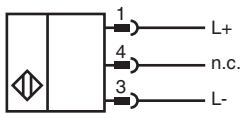

Connection Assignment

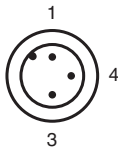

Wire colors in accordance with EN 60947-5-2

1	BN	(brown)
3	BU	(blue)
4	BK	(black)

Indication

Emitter

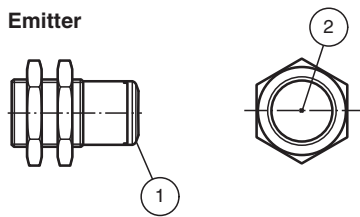

1	Operating display	green
2	Emitter	

Receiver

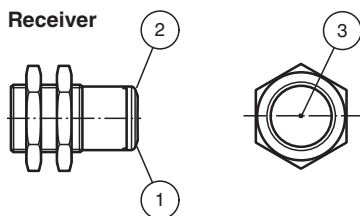

1	Operating display	green
2	Signal display	yellow
3	Receiver	

Release date: 2024-10-16 Date of issue: 2024-10-16 Filename: 70185125_eng.pdf

Characteristic Curve

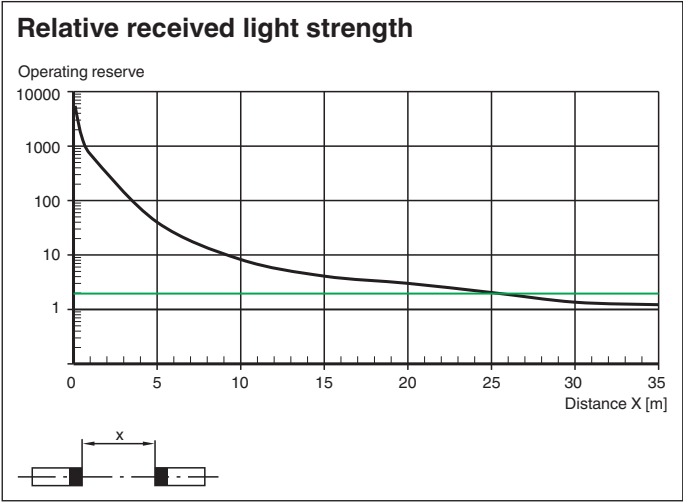
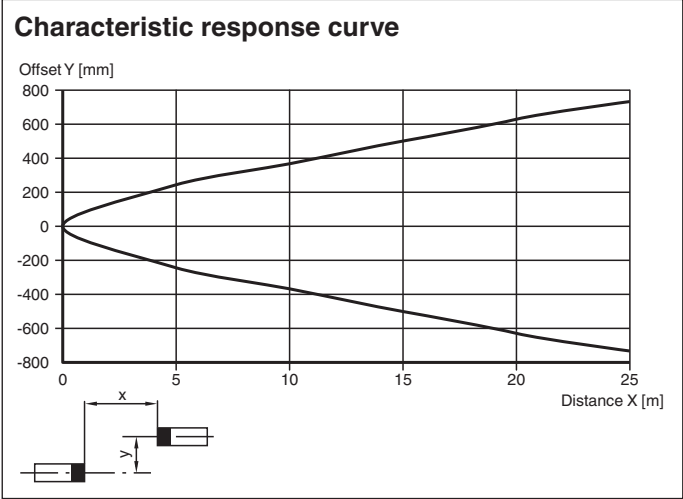

Release date: 2024-10-16 Date of issue: 2024-10-16 Filename: 70185125_eng.pdf