

Diffuse mode sensor

VT18-8-400-M/32/40a/118



- Array control panel with highly visible LED display
- Flashing power on LED in case of short-circuit
- Multiple device installation possible, no mutual interference (no cross-talk)
- Not sensitive to ambient light, even with switched energy saving lamps
- Protection class II

Diffuse mode sensor, M18 threaded housing design, metal housing, 400 mm detection range, red light, sensitivity adjuster, light/dark on, PNP output, M12 plug



Dimensions

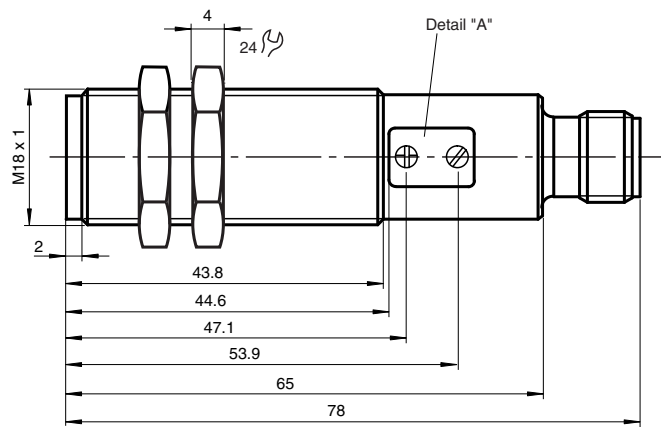

Detail "A"

Indicating/
Operating means

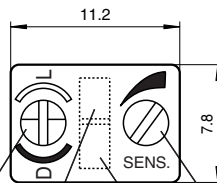

Light/dark switch

LED yellow

LED green

Sensing range adjuster

Unit connector



Release date: 2022-08-08 Date of issue: 2022-08-08 Filename: 801131_eng.pdf

Technical Data

General specifications		
Detection range		0 ... 400 mm , adjustable
Detection range min.		0 ... 25 mm
Detection range max.		0 ... 400 mm
Light source		LED
Light type		modulated visible red light , 660 nm
Diameter of the light spot		approx. 4 mm at a distance of 120 mm
Optical face		frontal
Ambient light limit		30000 Lux
Hysteresis	H	< 15 %
Functional safety related parameters		
MTTF _d		700 a
Mission Time (T _M)		20 a
Diagnostic Coverage (DC)		0 %
Indicators/operating means		
Operation indicator		LED green, flashes in case of short-circuit
Function indicator		LED yellow, lights up with receiver lit
Control elements		Sensing range adjuster, light-on/dark-on changeover switch
Electrical specifications		
Operating voltage	U _B	10 ... 30 V DC , class 2
Ripple		10 %
No-load supply current	I ₀	< 30 mA
Protection class		II , rated voltage ≤ 50 V AC with pollution degree 1-2 according to IEC 60664-1
Output		
Switching type		light/dark on, switchable
Signal output		1 PNP output, short-circuit protected, reverse polarity protected, open collector
Switching voltage		30 V DC
Switching current		max. 200 mA
Switching frequency	f	500 Hz
Response time		1 ms
Conformity		
Product standard		EN 60947-5-2
Approvals and certificates		
CE conformity		yes
EAC conformity		TR CU 020/2011
UL approval		cULus Listed, Type 1 enclosure
CCC approval		CCC approval / marking not required for products rated ≤36 V
Ambient conditions		
Ambient temperature		-25 ... 70 °C (-13 ... 158 °F)
Storage temperature		-30 ... 70 °C (-22 ... 158 °F)
Mechanical specifications		
Degree of protection		IP67
Connection		4-pin, M12 x 1 connector
Material		
Housing		brass, nickel-plated
Optical face		PMMA
Mass		60 g

Connection Assignment

Option: /32

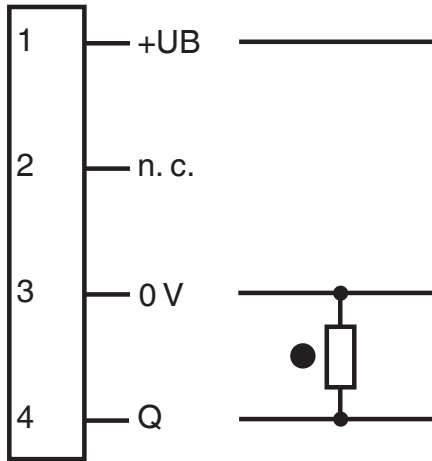

- = Light on
- = Dark on

Characteristic Curve

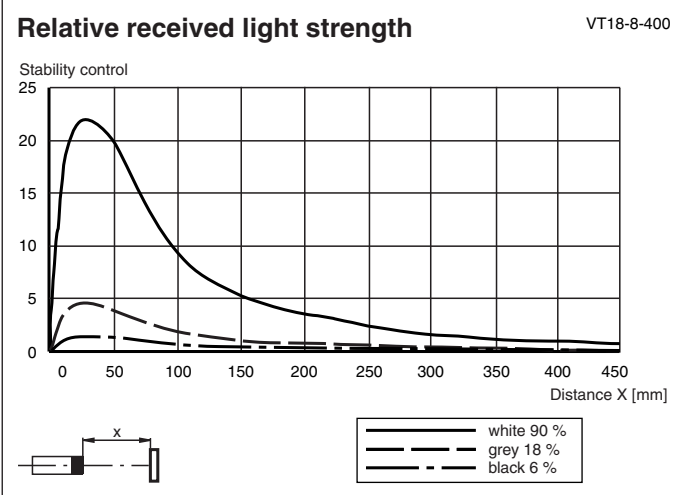
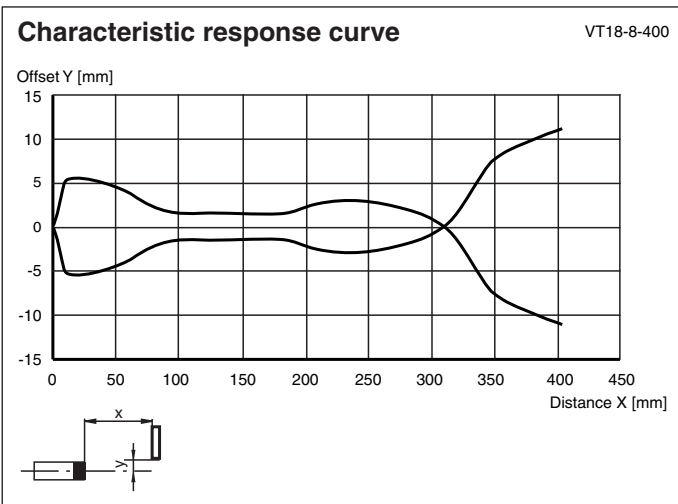

Release date: 2022-08-08 Date of issue: 2022-08-08 Filename: 801131_eng.pdf

Characteristic Curve

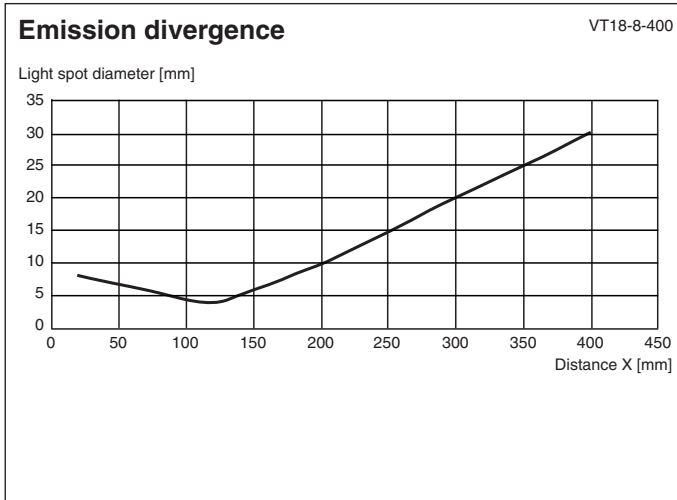
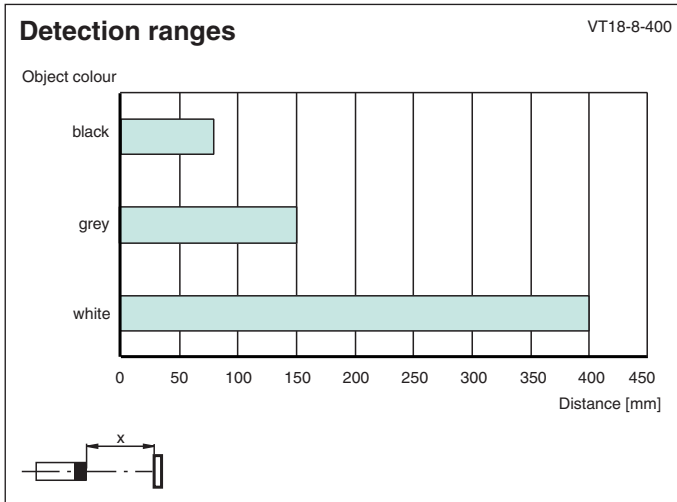

Release date: 2022-08-08 Date of issue: 2022-08-08 Filename: 801131_eng.pdf

Configuration

Sensitivity adjustment

- Turn sensitivity adjuster (counterclockwise) to minimum position.
- Place the object to be detected in the sensing range and turn the sensitivity adjuster clockwise until the yellow indication LED lights up. This setting indicates the position A of the sensitivity adjuster.
- Remove the object. Increase the sensitivity slowly (turning the sensitivity adjuster clockwise) until the yellow LED lights up again. This setting indicates the position B of the sensitivity adjuster.

Note:

In case of no background object, the LED won't light up, even in MAX. adjustment. In that case take care, that in normal operation conditions no temporal background object can appear in the sensing range (e. g. parked pallets). If this can not be excluded, place (only for adjustment matter) an object at the appropriate location. Then repeat this adjustment step. After finishing the adjustment this temporal object should be removed.

- For optimal setting, now turn the sensitivity adjuster to the middle position between the positions A and B.

