

# Diffuse mode sensor

## VT18-8-400-M-LAS/40a/118/128



- M18 threaded housing made of brass, nickel plated
- Visible red light, pulsed LASER light
- Array control panel with highly visible LED display
- Flashing power on LED in case of short-circuit
- Multiple device installation possible, no mutual interference (no cross-talk)
- Not sensitive to ambient light, even with switched energy saving lamps
- Protection class II

Diffuse mode sensor, M18 threaded housing design, metal housing, 400 mm detection range, red laser diode, sensitivity adjuster, light/dark on, push-pull output, M12 plug



### Dimensions

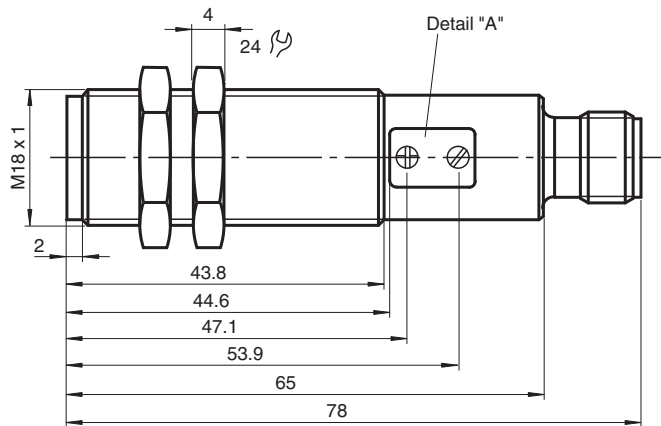

Detail "A"

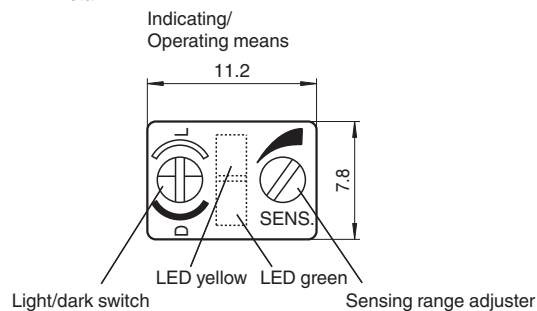

Release date: 2022-08-08 Date of issue: 2022-08-08 Filename: 801135\_eng.pdf

## Technical Data

General specifications		
Detection range		0 ... 400 mm , adjustable
Detection range min.		0 ... 25 mm
Detection range max.		0 ... 400 mm
Light source		laser diode
Light type		modulated visible red light
Laser nominal ratings		
Note		LASER LIGHT , DO NOT STARE INTO BEAM
Laser class		1
Wave length		655 nm
Beam divergence		31.5 mrad
Pulse length		4 $\mu$ s
Repetition rate		11.91 kHz
max. pulse energy		4.95 nJ
Diameter of the light spot		approx. 0.5 mm at a distance of 120 mm
Optical face		frontal
Ambient light limit		30000 Lux
Hysteresis	H	< 15 %
Functional safety related parameters		
MTTF <sub>d</sub>		700 a
Mission Time (T <sub>M</sub> )		20 a
Diagnostic Coverage (DC)		0 %
Indicators/operating means		
Operation indicator		LED green, flashes in case of short-circuit
Function indicator		LED yellow, lights up with receiver lit
Control elements		Sensing range adjuster, light-on/dark-on changeover switch
Electrical specifications		
Operating voltage	U <sub>B</sub>	10 ... 30 V DC , class 2
No-load supply current	I <sub>0</sub>	< 25 mA
Protection class		II , rated voltage $\leq$ 50 V AC with pollution degree 1-2 according to IEC 60664-1
Output		
Switching type		light/dark on, switchable
Signal output		Push-pull output, short-circuit protected, reverse polarity protected
Switching voltage		30 V DC
Switching current		max. 200 mA
Switching frequency	f	500 Hz
Response time		1 ms
Conformity		
Product standard		EN 60947-5-2
Compliance with standards and directives		
Standard conformity		
Laser class		IEC 60825-1:2007 Complies with 21 CFR 1040.10 and 1040.11 except for deviations pursuant to Laser Notice No. 50, dated June 24, 2007
Approvals and certificates		
CE conformity		yes
EAC conformity		TR CU 020/2011
UL approval		cULus Listed, Type 1 enclosure
CCC approval		CCC approval / marking not required for products rated $\leq$ 36 V
Ambient conditions		
Ambient temperature		-25 ... 55 °C (-13 ... 131 °F)
Storage temperature		-30 ... 70 °C (-22 ... 158 °F)
Mechanical specifications		
Degree of protection		IP67

## Technical Data

Connection	4-pin, M12 x 1 connector
Material	
Housing	brass, nickel-plated
Optical face	PMMA
Mass	60 g

## Connection Assignment

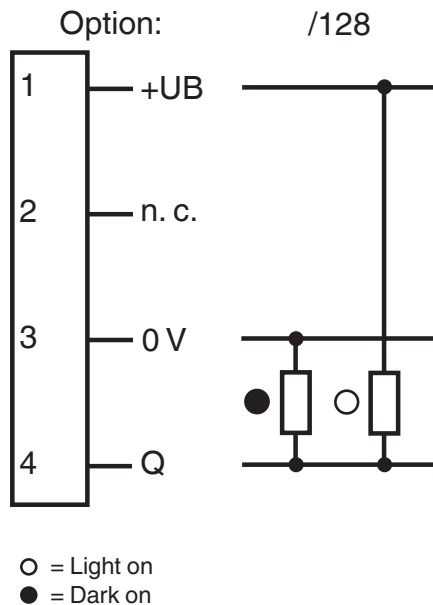

## Connection Assignment

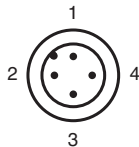

Wire colors in accordance with EN 60947-5-2

1	BN	(brown)
2	WH	(white)
3	BU	(blue)
4	BK	(black)

**Characteristic Curve**

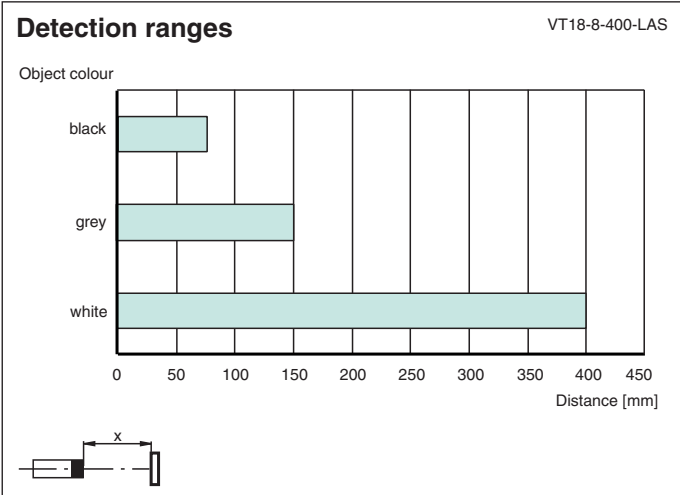
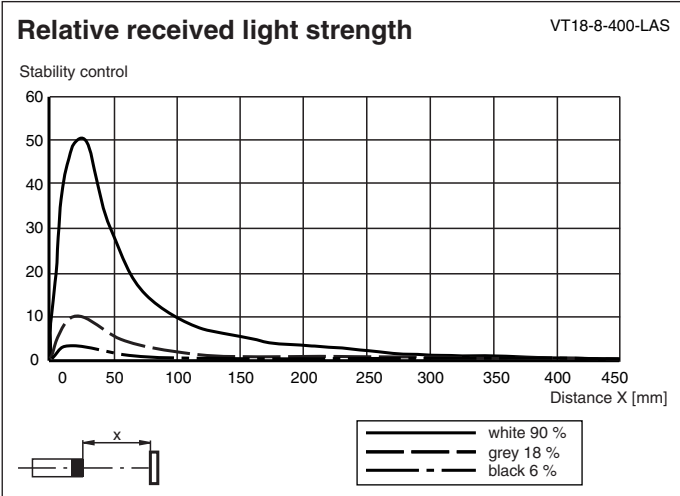
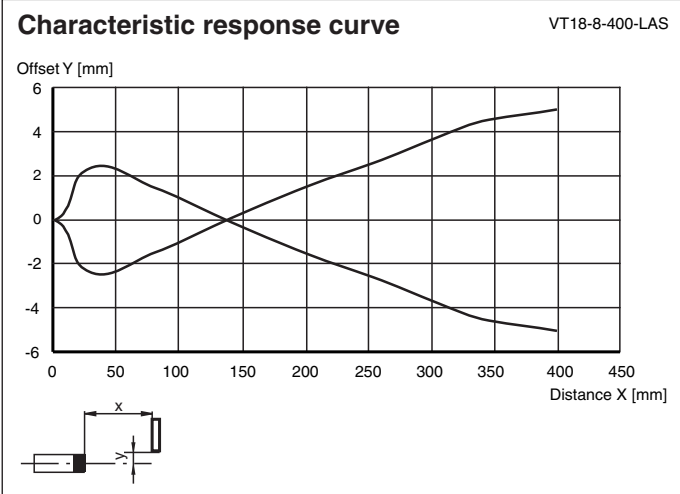

Release date: 2022-08-08 Date of issue: 2022-08-08 Filename: 801135\_eng.pdf

## Characteristic Curve

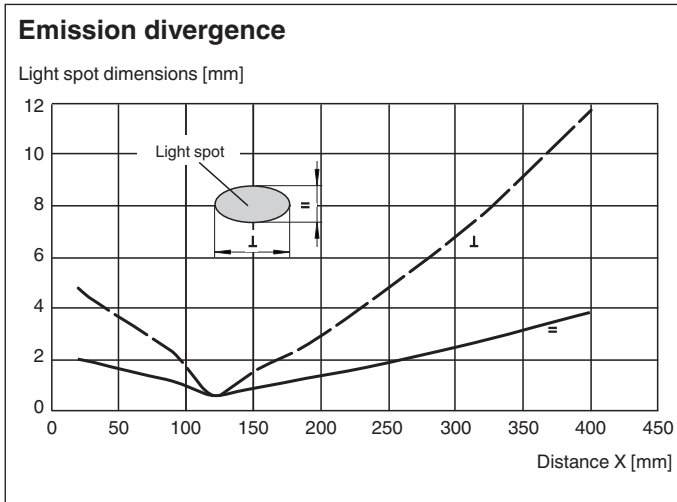







## Safety Information

**Laser Class 1 Information**

The irradiation can lead to irritation especially in a dark environment. Do not point at people!  
 Maintenance and repairs should only be carried out by authorized service personnel!  
 Attach the device so that the warning is clearly visible and readable.  
 The warning accompanies the device and should be attached in immediate proximity to the device.  
 Caution – Use of controls or adjustments or performance of procedures other than those specified herein may result in hazardous radiation exposure.

## Accessories

	<b>OMH-VL18</b>	Mounting Bracket with swivel nut
	<b>BF 18</b>	Mounting flange, 18 mm
	<b>BF 18-F</b>	Plastic mounting adapter, 18 mm
	<b>BF 5-30</b>	Universal mounting bracket for cylindrical sensors with a diameter of 5 ... 30 mm
	<b>V1-G-2M-PUR</b>	Female cordset single-ended M12 straight A-coded, 4-pin, PUR cable grey
	<b>V1-W-2M-PUR</b>	Female cordset single-ended M12 angled A-coded, 4-pin, PUR cable grey

Release date: 2022-08-08 Date of issue: 2022-08-08 Filename: 801135\_eng.pdf

## Configuration

### Sensitivity adjustment

- Turn sensitivity adjuster (counterclockwise) to minimum position.
- Place the object to be detected in the sensing range and turn the sensitivity adjuster clockwise until the yellow indication LED lights up. This setting indicates the position A of the sensitivity adjuster.
- Remove the object. Increase the sensitivity slowly (turning the sensitivity adjuster clockwise) until the yellow LED lights up again. This setting indicates the position B of the sensitivity adjuster.

#### Note:

In case of no background object, the LED won't light up, even in MAX. adjustment. In that case take care, that in normal operation conditions no temporal background object can appear in the sensing range (e. g. parked pallets). If this can not be excluded, place (only for adjustment matter) an object at the appropriate location. Then repeat this adjustment step. After finishing the adjustment this temporal object should be removed.

- For optimal setting, now turn the sensitivity adjuster to the middle position between the positions A and B.

