

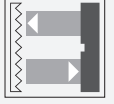

## Retroreflective sensor

RL29-55/25/73c/136

- Highly visible LED
- Powerful push-pull output
- Optimal price/power ratio
- Protection class II



Retroreflective sensor with polarization filter



## Dimensions

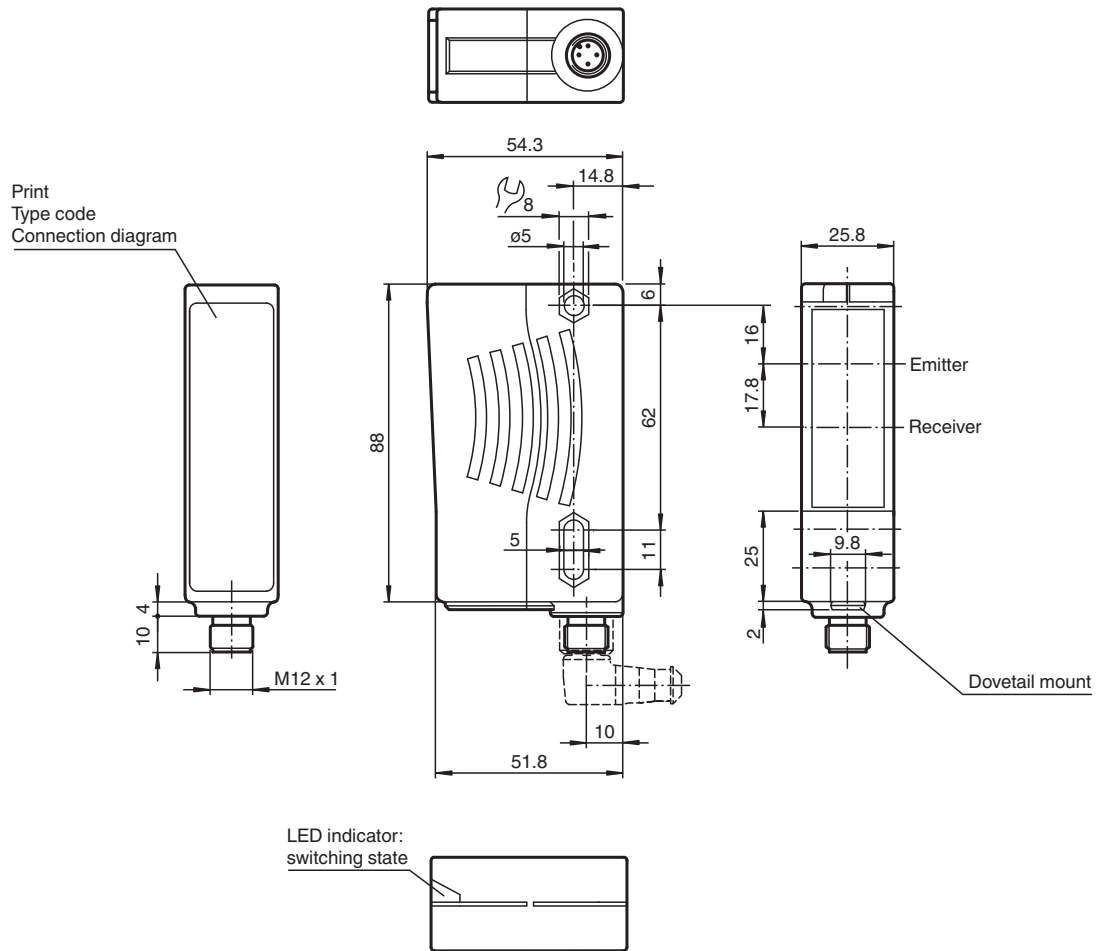

## Technical Data

### General specifications

Effective detection range	0.1 ... 7 m
Threshold detection range	10 m
Reference target	H85 reflector
Light source	LED, 660 nm
Light type	modulated visible red light
Polarization filter	yes
Diameter of the light spot	approx. 150 mm at a distance of 7 m
Opening angle	Emitter: 1.2 °, Receiver: 2 °
Ambient light limit	80000 Lux

### Functional safety related parameters

MTTF <sub>d</sub>	1982.2 a
Mission Time (T <sub>M</sub> )	20 a
Diagnostic Coverage (DC)	0 %

### Indicators/operating means

Function indicator	LED yellow, light with free light beam, flashes when falling short of the stability control
--------------------	---

### Electrical specifications

Operating voltage	U <sub>B</sub>	10 ... 30 V DC, class 2
Ripple		10 %
No-load supply current	I <sub>0</sub>	≤ 30 mA

### Output

Switching type	light-on
----------------	----------

## Technical Data

Signal output		2 push-pull (4 in 1) outputs, short-circuit protected, reverse polarity protected
Switching voltage		max. 30 V DC
Switching current		max. 100 mA
Switching frequency	f	500 Hz
Response time		1 ms
<b>Conformity</b>		
Product standard		EN 60947-5-2
<b>Approvals and certificates</b>		
EAC conformity		TR CU 020/2011
UL approval		cULus Listed, Class 2 Power Source, Type 1 enclosure
CCC approval		CCC approval / marking not required for products rated $\leq 36$ V
Approvals		CE, cULus Listed 57M3 (Only in association with UL Class 2 power supply; Type 1 enclosure)
<b>Ambient conditions</b>		
Ambient temperature		-25 ... 60 °C (-13 ... 140 °F)
Storage temperature		-40 ... 75 °C (-40 ... 167 °F)
<b>Mechanical specifications</b>		
Housing width		25.8 mm
Housing height		88 mm
Housing depth		54.3 mm
Degree of protection		IP65
Connection		Plastic connector M12 x 1, 4-pin
<b>Material</b>		
Housing		Plastic ABS
Optical face		plastic
Mass		70 g

## Connection Assignment

Option:

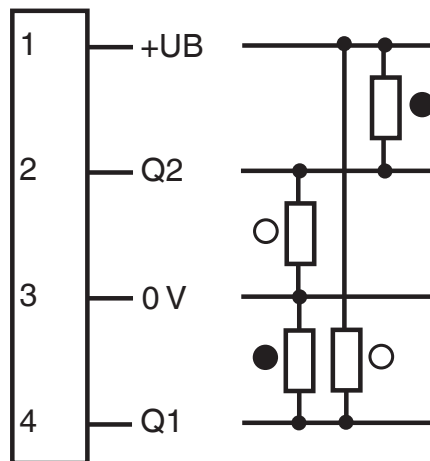

○ = Light on  
● = Dark on

## Connection Assignment

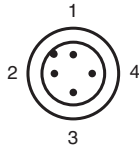

Wire colors in accordance with EN 60947-5-2





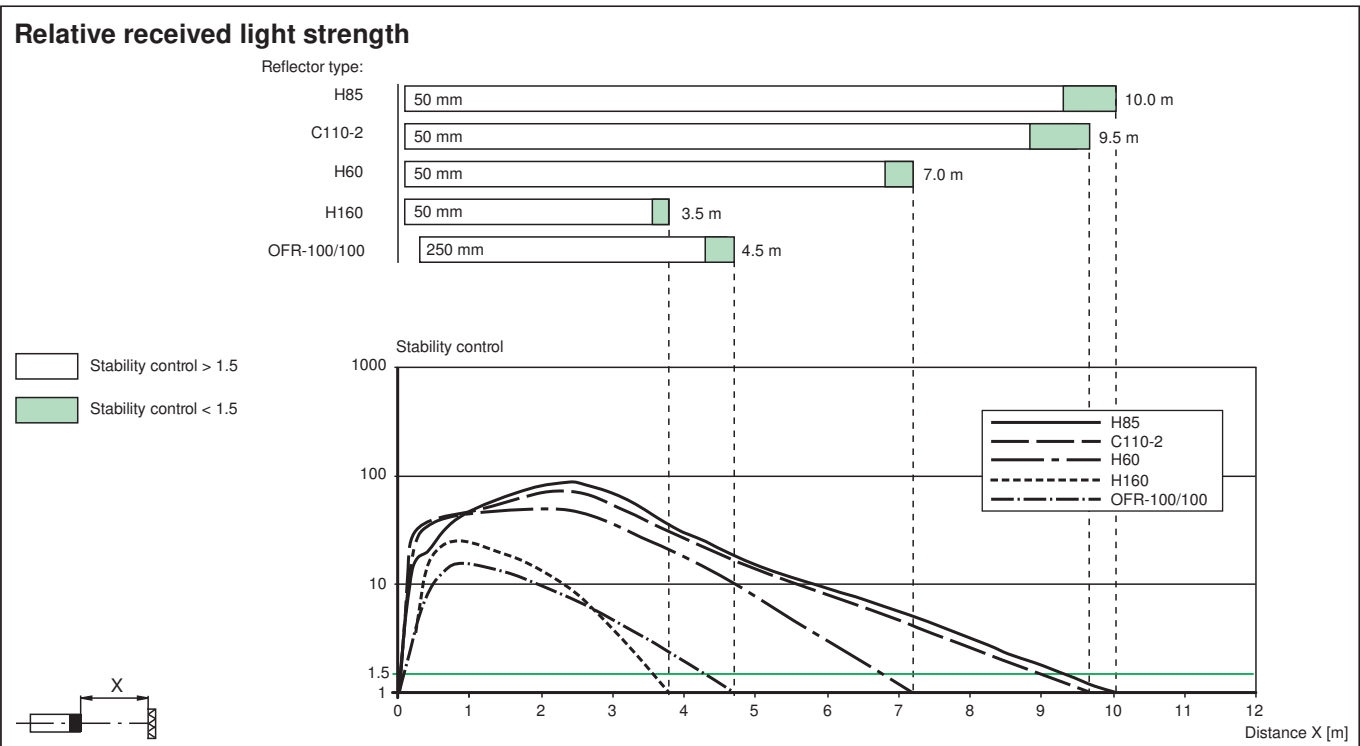
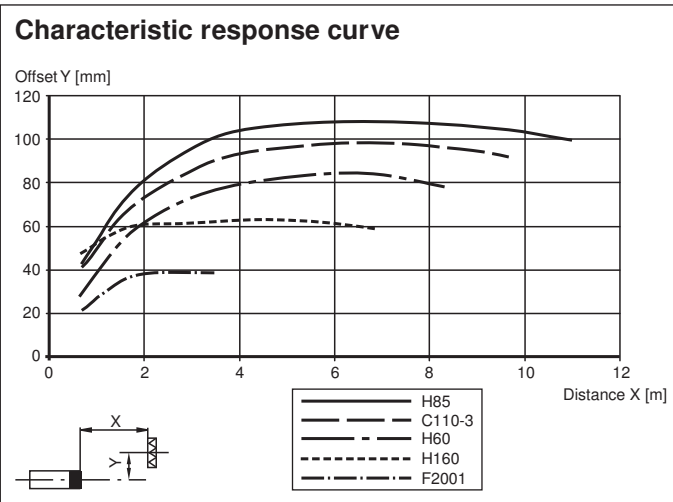

1	BN	(brown)
2	WH	(white)
3	BU	(blue)
4	BK	(black)

## Characteristic Curve



Release date: 2022-03-30 Date of issue: 2022-03-30 Filename: 801763\_eng.pdf

## Accessories

	<b>OMH-05</b>	Mounting aid for round steel $\varnothing$ 12 mm or sheet 1.5 mm ... 3 mm
	<b>OMH-21</b>	Mounting bracket: mounting aid for sensors in the RL* series
	<b>OMH-22</b>	Mounting aid for RL* series
	<b>OMH-RLK29-HW</b>	Mounting bracket for rear wall mounting
	<b>OMH-RL28-C</b>	Weld slag cover model
	<b>V1-G-2M-PUR</b>	Female cordset single-ended M12 straight A-coded, 4-pin, PUR cable grey
	<b>V1-W-2M-PUR</b>	Female cordset single-ended M12 angled A-coded, 4-pin, PUR cable grey