

Photoelectric slot sensor GL3-U/153



- Miniature design
- Optimized for the detection of small parts
- High switching frequency

Miniature photoelectric slot sensor for the detection of small parts, U-shaped housing design, 3.15 mm slot width, infrared light, NPN outputs, fixed cable



Function

The GL2 & GL3 miniature slot sensor is the smallest slot sensor in its family optimized to the requirements in semiconductors industry for small part detection. A wide voltage range of 5 V DC ... 30 V DC and a extreme fast response time of 25 μ s stands for the quality of this sensor. The GL2 & GL3 sensor can be directly connected to a comparator or Schmitt-trigger circuit. Due to a variety of different housings and an optimized housing concept offers the sensor a maximum of freedom in a crowded mounting environment.

Dimensions

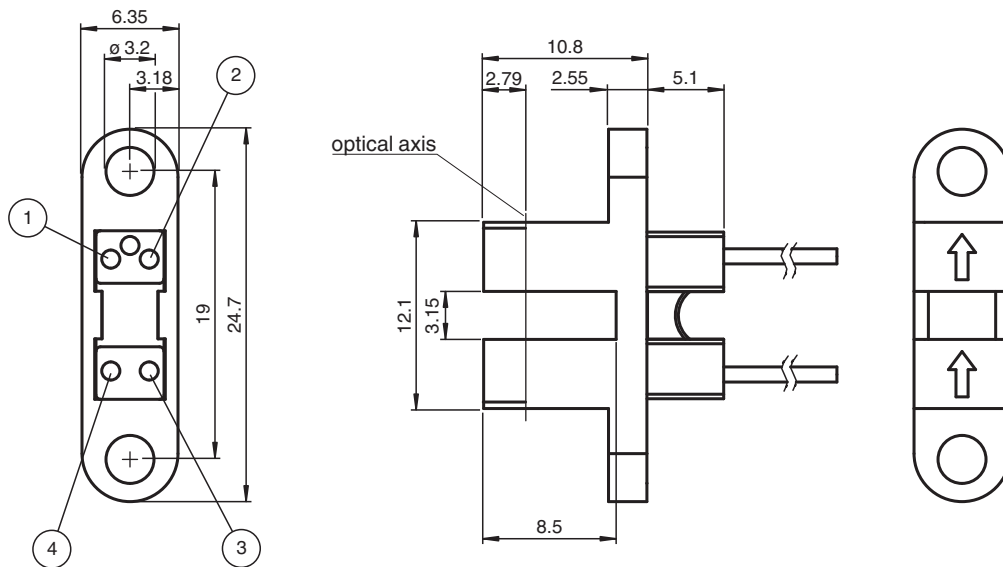

1	collector
2	emitter
3	anode
4	cathode

Technical Data

General specifications

Light source	IRED , 940 nm
Light type	IRED
Slot width	3.15 mm

Release date: 2024-06-24 Date of issue: 2024-06-24 Filename: 802747_eng.pdf

Technical Data

Slot depth		3.15 mm
Ambient light limit		1000 Lux
Functional safety related parameters		
MTTF _d		44332 a
Mission Time (T _M)		20 a
Diagnostic Coverage (DC)		0 %
Electrical specifications		
Operating voltage	U _B	5 ... 30 V DC
Ripple		10 %
Emitter		
Light type		940 nm IR light
Forward voltage	V _F	< 1.6 V
Peak forward voltage	V _{FM}	30 V
Forward current	I _F	50 mA
Reverse voltage	V _R	5 V
Reverse current	I _R	≤ 10 μA
Power dissipation		75 mW
Receiver		
Output type		NPN
C-E breakdown voltage	V _{CEO}	30 V
E-C breakdown voltage	V _{ECO}	5 V
Collector dark current	I _{CEO}	< 1 μA
Collector DC current	I _C	20 mA
Power dissipation	P _D	75 mW
Output		
Signal output		1 NPN , photo transistor
Switching voltage		max. 30 V DC
Switching current		20 mA
Response time		25 μs
Approvals and certificates		
EAC conformity		TR CU 020/2011
CCC approval		CCC approval / marking not required for products rated ≤36 V
Ambient conditions		
Ambient temperature		-20 ... 85 °C (-4 ... 185 °F)
Storage temperature		-40 ... 85 °C (-40 ... 185 °F)
Mechanical specifications		
Core cross section		4 x 0.08 mm ²
Degree of protection		IP30
Connection		610 mm, PVC cable , Individual colored wires
Material		
Housing		PC
Mass		7 g
Dimensions		
Height		15.9 mm
Width		6.35 mm
Depth		24.7 mm

Connection Assignment

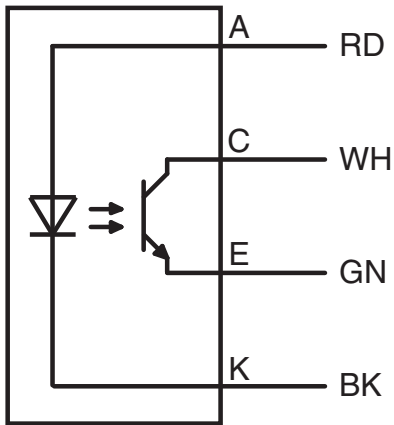

Characteristic Curve

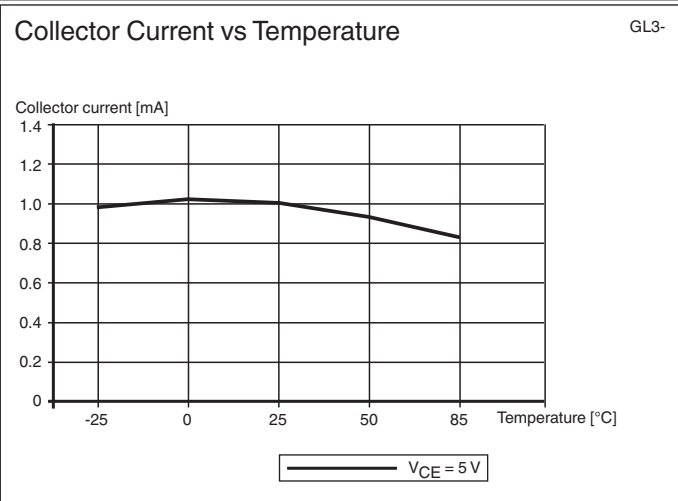
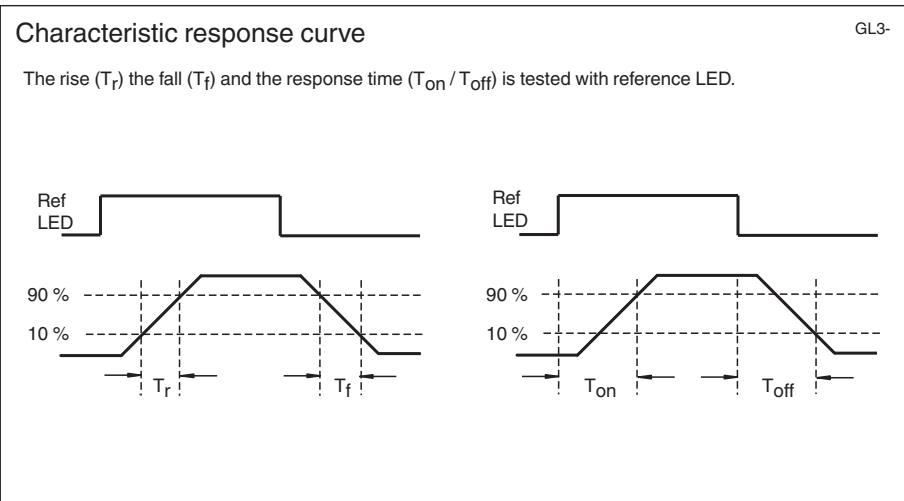

Release date: 2024-06-24 Date of issue: 2024-06-24 Filename: 802747_eng.pdf

Characteristic Curve

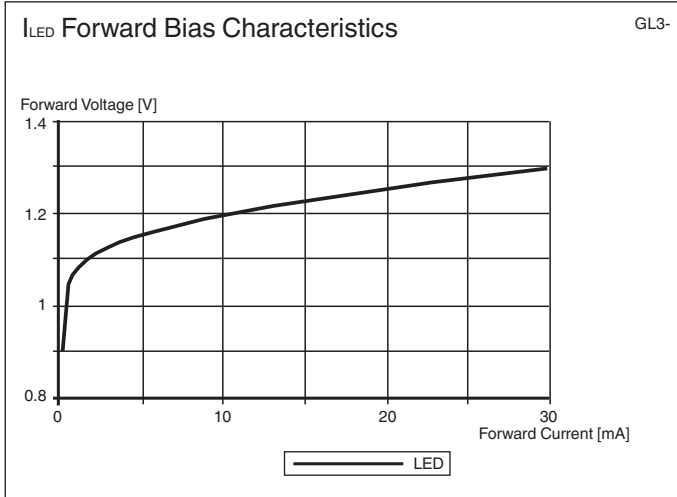
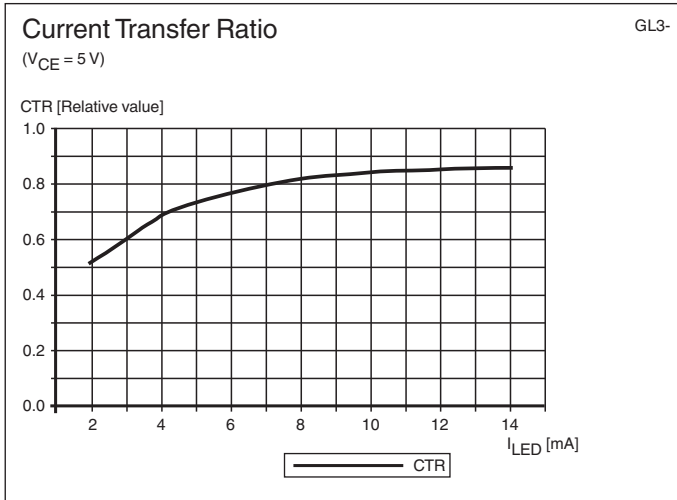
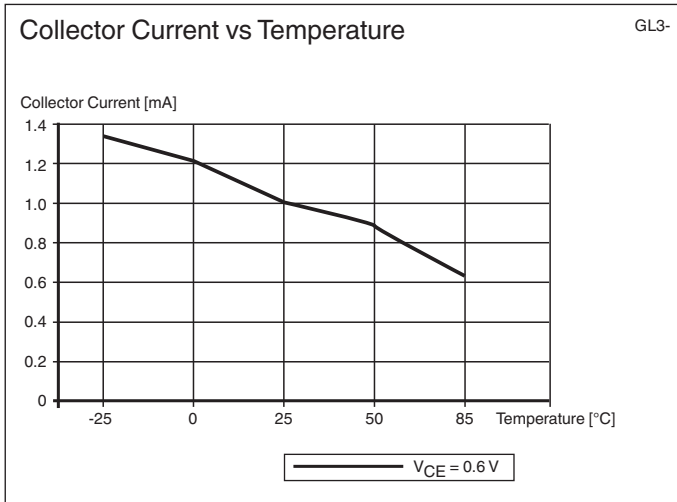

Release date: 2024-06-24 Date of issue: 2024-06-24 Filename: 802747_eng.pdf

Characteristic Curve

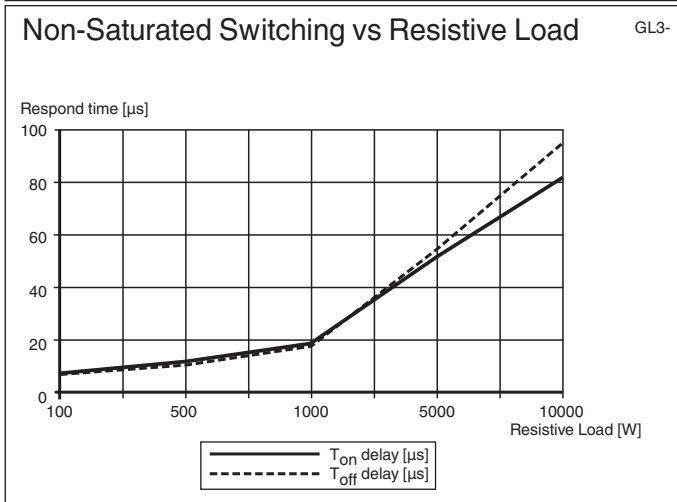
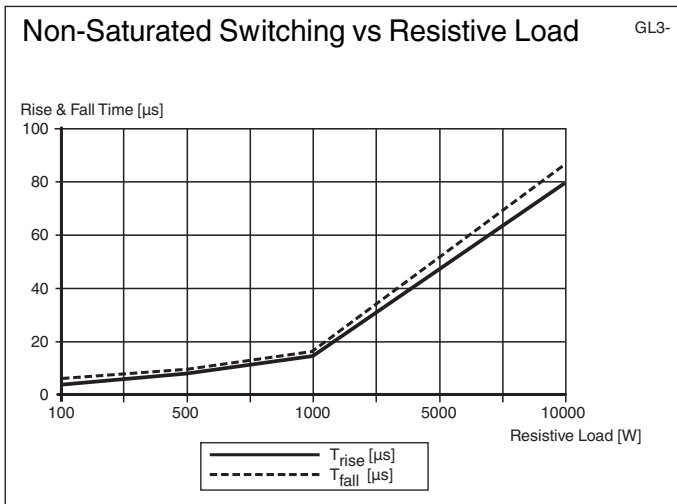

Release date: 2024-06-24 Date of issue: 2024-06-24 Filename: 802747_eng.pdf

Connection example

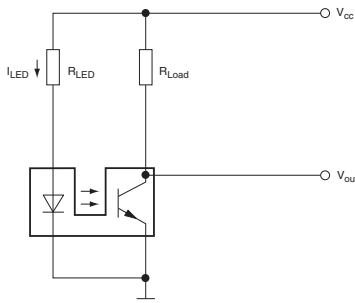

3 simple steps:

- Choose power supply
- Choose LED current (set resistor R_{LED})
- Choose load current (set resistor R_{LOAD})

Possible connections

<p>Circuit with voltage comparator</p>	<p>Circuit with additional transistor</p>
<p>Circuit with Op Amp</p>	<p>Circuit with PNP transistor output</p>

Release date: 2024-06-24 Date of issue: 2024-06-24 Filename: 802747_eng.pdf