

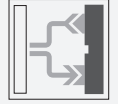

Fiber optic sensor SU19.1/102/115



- Classic line with display
- AGC (Automatic Gain Control) for faster teach-in
- Gang mounting for easy wiring
- Transparency recognition
- 30 μ s High Speed Mode
- Slave module

Classic Series fiber optic sensor with display, slave module, NPN output, fixed cable



Function

The fiber optics amplifier SU19 with display was developed to set a benchmark with the most comfortable and user-friendly interface. This simplicity of the settings decreases the costs of ownership significantly. The whole Teach-In process of objects is time-saving due to an easy Teach-In algorithm. The high resolution 4-digit percentage display indicates current values and thresholds with highest accuracy. Wire-saving and the replacement of devices is designed user-friendly and time-saving due to gang mounting on the rear.

Dimensions

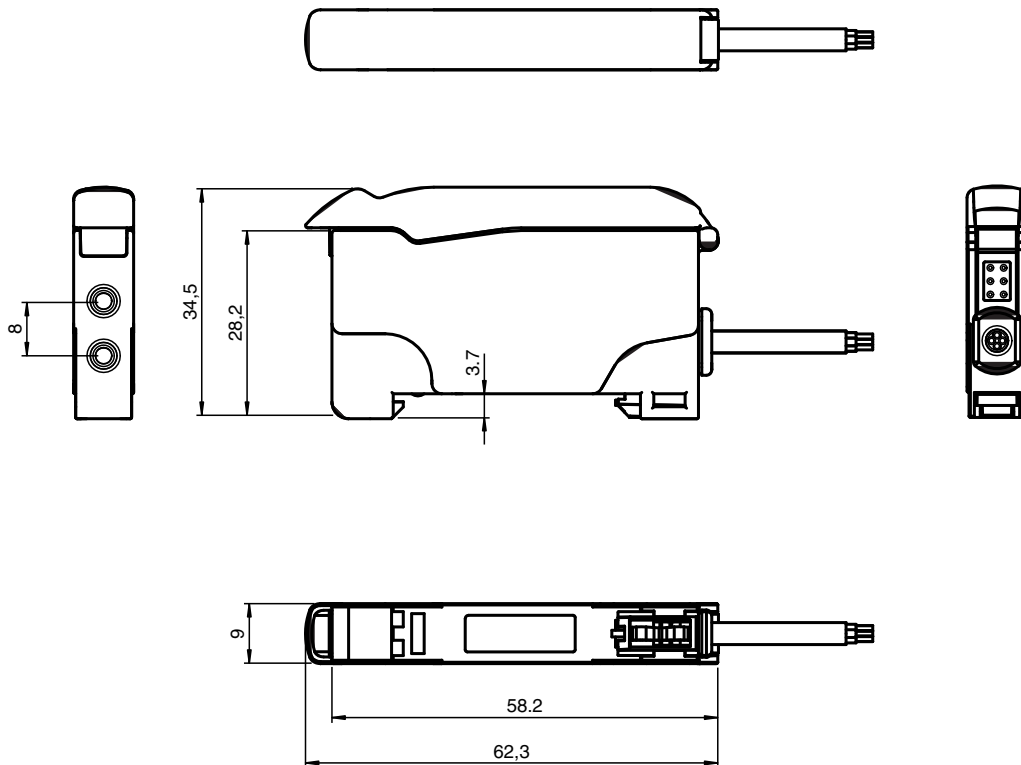

Technical Data

| General specifications | | |
|--------------------------------------|----------------|--|
| Sensor range | | up to 150 mm (KLR-C02-2,2-2,0-K146) |
| Detection range | | up to 450 mm (KLE-C01-2,2-2,0-K116) |
| Light source | | LED |
| Light type | | modulated visible red light , 660 nm |
| Ambient light limit | | 10000 Lux |
| Gang mounting | | maximum 20 units |
| Functional safety related parameters | | |
| MTTF _d | | 500 a |
| Mission Time (T _M) | | 20 a |
| Diagnostic Coverage (DC) | | 0 % |
| Indicators/operating means | | |
| Operation indicator | | Power on: static illumination , Undervoltage indicator: Green LED, pulsing (approx. 0.8 Hz) , short-circuit : LED green flashing (approx. 4 Hz) |
| Diagnostics indicator | | 7-segment display |
| Function indicator | | LED yellow: static illumination switching state, flashes when falling short of the operating reserve |
| Control elements | | Button (Mode) for menu choice ; Button (Set) for Teach-In ; Button (Up/Down) for fine adjusting and parameterization |
| Electrical specifications | | |
| Operating voltage | U _B | 10 ... 30 V DC |
| Ripple | | 10 % |
| No-load supply current | I ₀ | ≤ 30 mA |
| Output | | |
| Switching type | | light/dark on selectable programmable |
| Signal output | | 1 NPN, short-circuit protected open collector |
| Switching voltage | | max. 30 V DC |
| Switching current | | max. 100 mA , resistive load |
| Voltage drop | U _d | ≤ 2 V DC at 100 mA ; ≤ 0.7 V at 10 mA |
| Switching frequency | f | High speed mode: 16 kHz , Standard mode: 3 kHz , High resolution: 250 Hz ~ 3 kHz (selection by the sensor), Automatic: 250 Hz , Glass mode: 250 Hz |
| Response time | | High speed mode: 30 μs , Standard mode: 160 μs , High resolution: 2 ms , Automatic: 160 μs ~ 2 ms (choice by the sensor), Glass mode: 2 ms |
| Repeat accuracy | R | ≤ 0.5 % of adjusted sensor range |
| Timer function | | ON-delay, OFF-delay, one shot, pulse extension ; adjustable 0 ... 999 ms in 1 ms increments |
| Conformity | | |
| Product standard | | EN 60947-5-2 |
| Approvals and certificates | | |
| UL approval | | cULus Listed, Class 2 Power Source, Type 1 enclosure |
| CCC approval | | CCC approval / marking not required for products rated ≤36 V |
| Ambient conditions | | |
| Ambient temperature | | -10 ... 55 °C (14 ... 131 °F) |
| Storage temperature | | -20 ... 70 °C (-4 ... 158 °F) |
| Mechanical specifications | | |
| Housing width | | 9 mm |
| Housing height | | 34.5 mm |
| Housing depth | | 62.3 mm |
| Degree of protection | | IP50 |
| Connection | | 2 m fixed cable , 1 x 0.25 mm ² , PVC |
| Material | | |
| Housing | | PC |
| Mass | | 45 g |

Connection Assignment

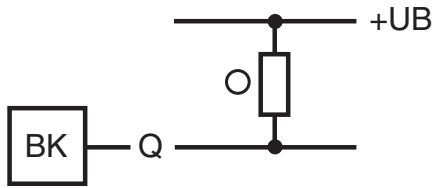

○ = Light on
● = Dark on

Assembly

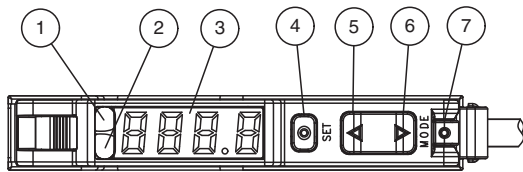





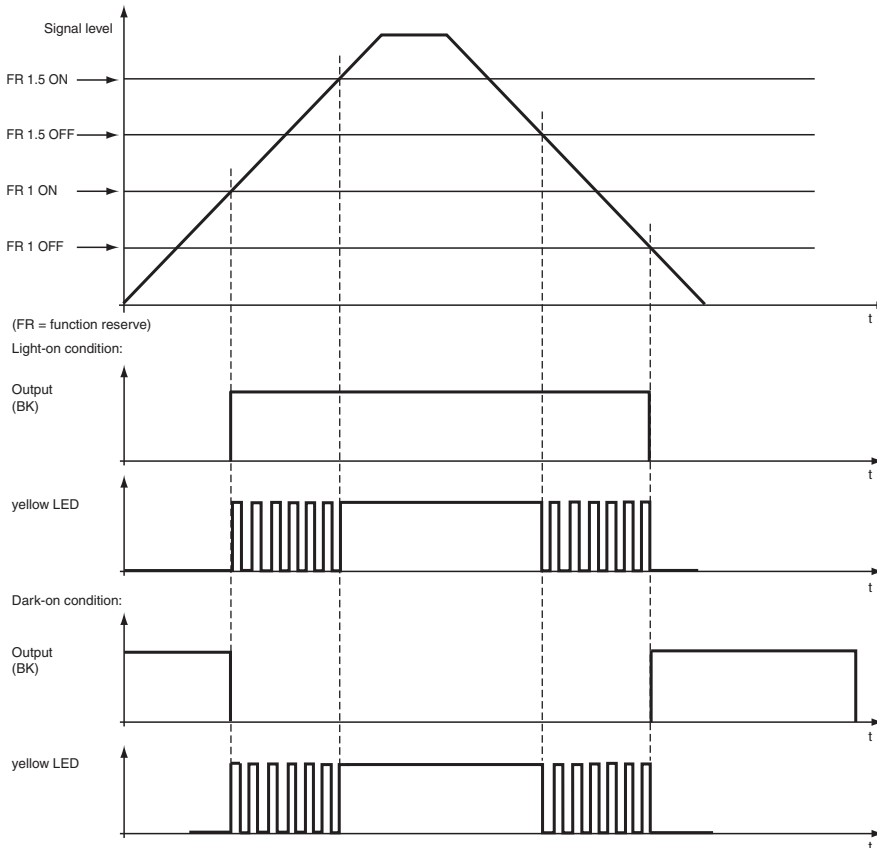











| | | |
|---|-------------------|--------|
| 1 | Operating display | green |
| 2 | Signal display | yellow |
| 3 | Display | |
| 4 | Button: Set | |
| 5 | Button: Up | |
| 6 | Button: Down | |
| 7 | Button: Mode | |

LED indicators and operating chart:



Release date: 2023-04-04 Date of issue: 2023-04-04 Filename: 805077_eng.pdf

Accessories

| | | |
|---|------------------------------|---|
|  | HPF-D032 | Plastic fiber optic |
|  | KLR-C02-2,2-2,0-K146 | Plastic fiber optic - diffuse |
|  | KLR-C02-2,2-2,0-K70 | Plastic fiber optic - diffuse |
|  | KLR-C02-1,0-2,0-K75 | Plastic fiber optic - diffuse |
|  | KLR-C09-1,25-2,0-K76 | Plastic fiber optic - diffuse |
|  | KLR-C09-1,25-2,0-K74 | Plastic fiber optic - diffuse |
|  | KLR-C16-2,2-2,0-K71 | Plastic fiber optic - diffuse |
|  | KHR-C02-2,2-2,0-K131 | Plastic fiber optic - diffuse |
|  | KHTR-C02-2,2-2,0-K88 | Plastic fiber optic - diffuse |
|  | KLE-C01-2,2-2,0-K116 | Plastic fiber optic - thru-beam |
|  | KLE-C01-2,2-2,0-K103 | Plastic fiber optic - thru-beam |
|  | KLE-C01-2,2-2,0-K102 | Plastic fiber optic - thru-beam |
|  | KLE-C01-2,2-2,0-K101 | Plastic fiber optic - thru-beam |
|  | KLE-C01-2,2-2,0-K113 | Plastic fiber optic - thru-beam |
|  | KLE-C01-1,0-2,0-K120 | Plastic fiber optic - thru-beam |
|  | KHE-C01-2,2-2,0-K122 | Plastic fiber optic - thru-beam |
|  | KHTE-C01-2,2-2,0-K118 | Plastic fiber optic - thru-beam |
| | LHE 00-1,1-1,0-20M4 | Glass fiber optic - thru-beam with silicon covering |

Teach-In methods

Maximum Teach-In

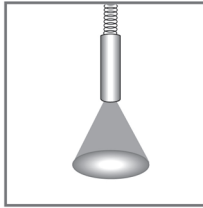
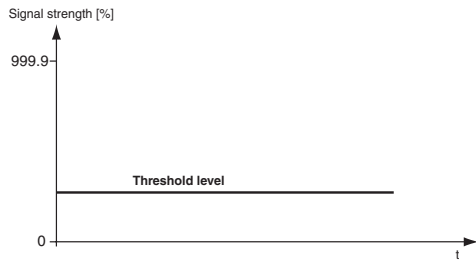

- Gain is set to maximum.
- Threshold is set to minimum.
- Maximum sensitivity is achieved.

Position Teach-In

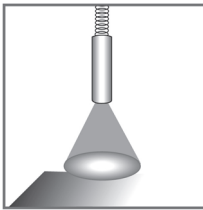
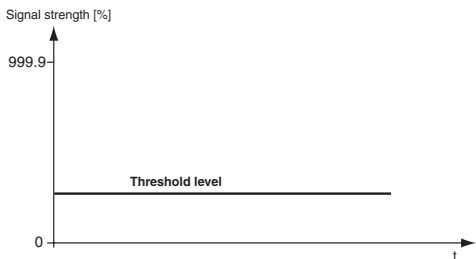

- Sensor set the optimum gain.
- Threshold is set to minimum.
- Signal received is ~ 100 %.

2-Point Teach-In

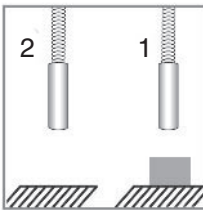
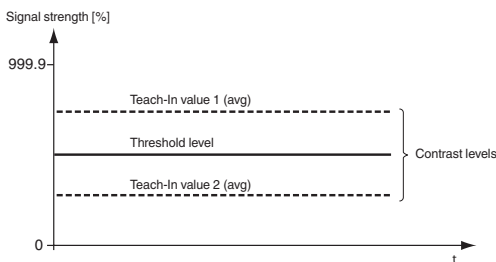

- Sensor set the optimum gain.
- Threshold is set in the middle of the 2 average taught values.

Dynamic Teach-In

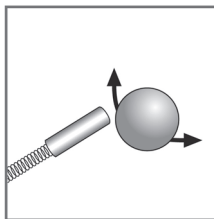
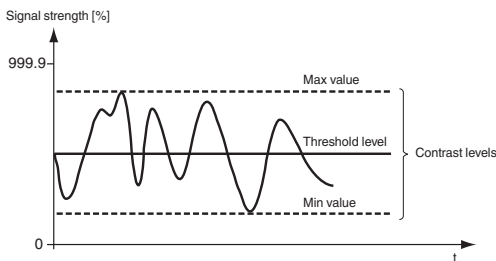

- Sensor set the optimum gain.
- Threshold is placed in the middle of the minimum and maximum taught values.

Glass detection Teach-In

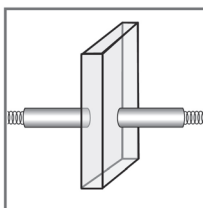
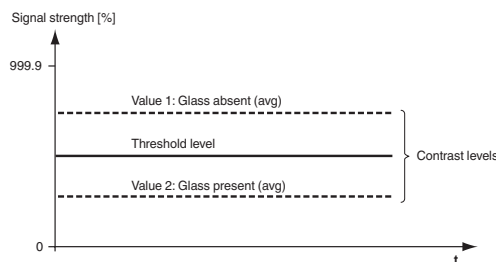

- Sensor set the optimum gain.
- Threshold is set in the middle of the 2 average taught values.

Release date: 2023-04-04 Date of issue: 2023-04-04 Filename: 805077_eng.pdf

Assembly

Selection of the maximum number of connectible slave modules to a master module for cross-talk suppression via bridge contacts.

| Number of linkable units | Operating modes | | | |
|--------------------------|-----------------|-----------------|------------|-----------------|
| | Standard | High Resolution | Auto | Glass detection |
| 6u | 6 modules | 6 modules | 6 modules | 6 modules |
| 12u | 12 modules | 12 modules | 12 modules | 12 modules |
| 18u | 18 modules | 18 modules | 18 modules | 18 modules |

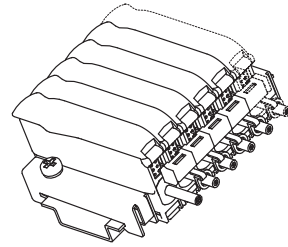

If 12u is selected, the switch-on delay doubles.

If 18u is selected, the switch-on delay triples.

When connecting several modules using bridge contacts, please ensure that the black blind pins on the bridge contacts are cut off. The outer blind pins must be retained only on the two outer bridge contacts. This is to seal off the pins that are not in use.

Master modules must **not** be connected to one another via the bridge contacts.

The power applied to the external input on the master module supplies the master module and all connected slave modules.

A master module is required to operate a slave module.

Information regarding current consumption:

- a) Maximum of 20 units (19 slaves per master). Maximum current consumption = 20 mA per unit.
- b) Maximum of 10 units (9 slaves per master). Maximum current consumption = 70 mA per unit.
- c) Maximum of 8 units (7 slaves per master). Maximum current consumption = 110 mA per unit.

Pay attention to the protective cover over the bridge contacts of the master modules

Menu structure

The menu structure has three levels:

Level 0: Press the "mode"-button. Select the required function via the "±" -button.
Press the "set"-button for confirmation.

Level 1: Select the required function via the "±" -button.
Press the "set"-button to confirm your selection.

Level 2: Use the "±" - button to select the required time delay in 1ms steps.
Press the "set"-button to confirm your selection.

To exit the menu, press the "mode"-button.

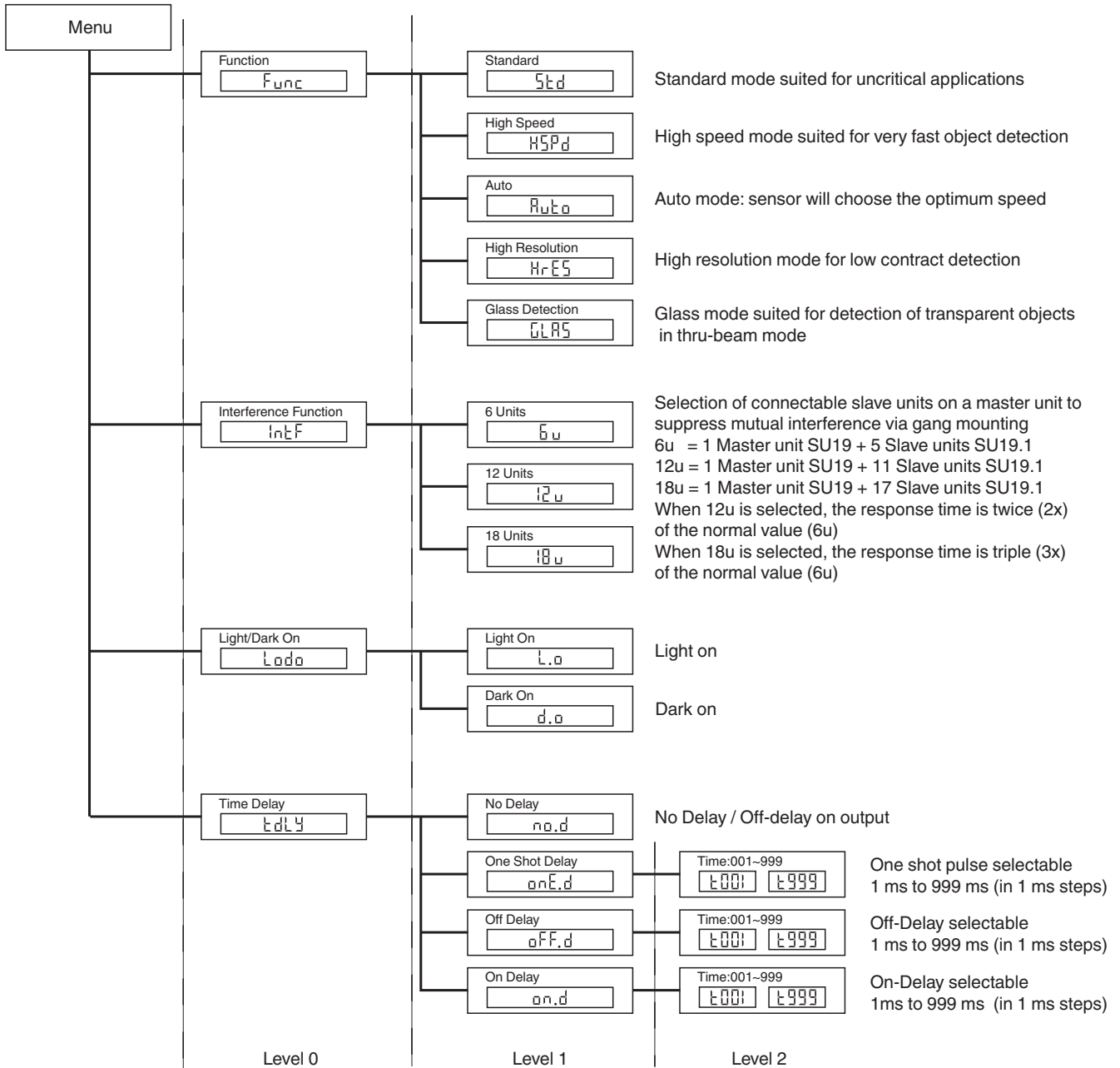

Thru-Beam Optical Fiber Selection Table

Release date: 2023-04-04 Date of issue: 2023-04-04 Filename: 805077_ eng.pdf

| Head type | Mounting | Designation | Core | Detection range | Fiber cross-section | Minimum object size | Length of fiber optics | Bending radius | Dimensional drawing | Special Properties |
|-----------------|----------------|----------------------|------|-----------------|---------------------|---------------------|------------------------|----------------|---------------------|---|
| High-precision | | | | | | | | | | |
| Thread | M3 | KLE-C01-1.0-2.0-K120 | PMMA | 20 mm | 0.25 mm | 0.05 mm | 2 m | At least 10 mm | | |
| Thread | M4 | KLE-C01-1.0-2.0-K119 | PMMA | 20 mm | 0.25 mm | 0.05 mm | 2 m | At least 10 mm | | Four times higher detection range with auxiliary lens K-LA01/ eight times higher detection range with auxiliary lens K-LA06 Lateral optical face with K-LA02 |
| Thread | M3 x 0.5 | KLE-C04-1.0-2.0-K104 | PMMA | 70 mm | 4 x 0.25 mm | 0.12 mm | 2 m | At least 15 mm | | |
| Cylindrical | Dia. 2 mm | KLE-C01-1.0-2.0-K105 | PMMA | 20 mm | 0.25 mm | 0.05 mm | 2 m | At least 10 mm | | |
| Cylindrical | Dia. 1.5 mm | KLE-C01-1.0-2.0-K107 | PMMA | 20 mm | 0.25 mm | 0.05 mm | 2 m | At least 10 mm | | |
| Cylindrical | Dia. 1.5 mm | KLE-C04-1.0-2.0-K108 | PMMA | 70 mm | 4 x 0.25 mm | 0.12 mm | 2 m | At least 15 mm | | |
| Cylindrical | Dia. 2 mm | KLE-C04-1.0-2.0-K106 | PMMA | 70 mm | 4 x 0.25 mm | 0.05 mm | 2 m | At least 15 mm | | |
| Highly flexible | | | | | | | | | | |
| Thread | M3 | KHE-C01-1.0-2.0-K125 | PMMA | 50 mm | 0.5 mm | 0.15 mm | 2 m | At least 1 mm | | Only 1 mm bending radius |
| Thread | M3 | KHE-C01-2.2-2.0-K122 | PMMA | 200 mm | 1 mm | 0.25 mm | 2 m | At least 2 mm | | Only 2 mm bending radius |
| Thread | M4 x 0.7 /M2.6 | KHE-C01-1.0-2.0-K124 | PMMA | 50 mm | 0.5 mm | 0.15 mm | 2 m | At least 1 mm | | Four times higher detection range with auxiliary lens K-LA01/ eight times higher detection range with auxiliary lens K-LA06 Lateral optical face with K-LA02/ Only 1 mm bending radius |

Release date: 2023-04-04 Date of issue: 2023-04-04 Filename: 805077_eng.pdf

| Head type | Mounting | Designation | Core | Detection range | Fiber cross-section | Minimum object size | Length of fiber optics | Bending radius | Dimensional drawing | Special Properties |
|-------------|----------------|----------------------|------|-----------------|---------------------|---------------------|------------------------|----------------|---------------------|--|
| Thread | M6 | KHE-C01-2.2-2.0-K121 | PMMA | 200 mm | 1.0 mm | 0.25 mm | 2 m | At least 2 mm | | Only 2 mm bending radius |
| Cylindrical | Dia. 1.5 mm | KHE-C01-1.0-2.0-K139 | PMMA | 50 mm | 0.5 mm | 0.05 mm | 2 m | At least 1 mm | | Only 1 mm bending radius |
| Cylindrical | Dia. 3 mm | KHE-C01-2.2-2.0-K126 | PMMA | 50 mm | 0.5 mm | 0.15 mm | 2 m | At least 1 mm | | Only 1 mm bending radius |
| Cylindrical | Dia. 3 mm | KHE-C01-2.2-2.0-K123 | PMMA | 200 mm | 1 mm | 0.25 mm | 2 m | At least 2 mm | | Only 2 mm bending radius |
| Right angle | Dia. 15 x 5 | KHE-C01-2.2-2.0-K137 | PMMA | 35 mm | 0.5 mm | 0.15 mm | 2 m | At least 1 mm | | Only 1 mm bending radius |
| Right angle | Dia. 15 x 5 | KHE-C01-2.2-2.0-K140 | PMMA | 150 mm | 1 mm | 0.25 mm | 2 m | At least 2 mm | | Only 2 mm bending radius |
| Flexible | | | | | | | | | | |
| Thread | M3 x 0.5 /M2.6 | KLE-C01-1.3-2.0-K112 | PMMA | 200 mm | 1 mm | 0.25 mm | 2 m | At least 25 mm | | Four times higher detection range with auxiliary lens K-LA01/ Lateral optical face with K-LA02 |
| Thread | M3 x 0.5 | KLE-C01-2.2-2.0-K103 | PMMA | 220 mm | 1 mm | 0.25 mm | 2 m | At least 25 mm | | |
| Thread | M4 x 0.7 /M2.6 | KLE-C01-2.2-2.0-K102 | PMMA | 220 mm | 1 mm | 0.25 mm | 2 m | At least 25 mm | | Four times higher detection range with auxiliary lens K-LA01/ eight times higher detection range with auxiliary lens K-LA06 Lateral optical face with K-LA02 |
| Thread | M6 | KLE-C01-2.2-2.0-K161 | PMMA | 330 mm | 1 mm | 0.32 mm | 2 m | At least 25 mm | | |

Release date: 2023-04-04 Date of issue: 2023-04-04 Filename: 805077_eng.pdf

| Head type | Mounting | Designation | Core | Detection range | Fiber cross-section | Minimum object size | Length of fiber optics | Bending radius | Dimensional drawing | Special Properties |
|----------------------|--------------|----------------------|------|---|---------------------|---------------------|------------------------|----------------|---------------------|--|
| Thread | M2.6 | KLE-C01-2.2-2.0-K113 | PMMA | 200 mm | 1 mm | 0.25 mm | 2 m | At least 25 mm | | Four times higher detection range with auxiliary lens K-LA01/ Lateral optical face with K-LA02 |
| Cylindrical | Dia. 2 mm | KLE-C01-1.3-2.0-K114 | PMMA | 220 mm | 1 mm | 0.25 mm | 2 m | At least 25 mm | | |
| Cylindrical | Dia. 5 mm | KLE-C01-2.2-2.0-K101 | PMMA | 220 mm | 1 mm | 0.32 mm | 2 m | At least 25 mm | | |
| Flexible tip | | | | | | | | | | |
| Thread | M4 | KLE 00-2.2-2.0-K55 | PMMA | 228 mm | 1 mm | | 2 m | At least 25 mm | | |
| Long detection range | | | | | | | | | | |
| Thread | M3 | KLE-C01-2.2-2.0-K116 | PMMA | 450 mm | 1.5 mm | 0.35 mm | 2 m | At least 40 mm | | |
| Thread | M8 x 1 | FEF-PLT1 | PMMA | 6000 mm calculated value in relation to 2 m fiber optics length | 1 mm | | 1 m | At least 25 mm | | Narrow light beam |
| Thread | M8 x 1 | FEF-PLT1-L2 | PMMA | 6000 mm calculated value in relation to 2 m fiber optics length | 1 mm | | 2 m | At least 25 mm | | Narrow light beam |
| Thread | M8 x 1 | FEF-PLT1-L5 | PMMA | 6000 mm calculated value in relation to 2 m fiber optics length | 1 mm | | 4 m | At least 25 mm | | Narrow light beam |
| Cylindrical | Dia. 3 mm | KLE-C01-2.2-2.0-K117 | PMMA | 400 mm | 1.5 mm | 0.35 mm | 2 m | At least 25 mm | | |
| Lateral optical face | | | | | | | | | | |
| Cylindrical | Dia. 4.75 mm | KHE-C01-2.2-2.0-K136 | PMMA | 50 mm | 0.5 mm | 0.15 mm | 2 m | At least 1 mm | | Only 1 mm bending radius |

Release date: 2023-04-04 Date of issue: 2023-04-04 Filename: 805077_eng.pdf

| Head type | Mounting | Designation | Core | Sensing range | Fiber cross-section | Length of fiber optics | Bending radius | Dimensional drawing | Special Properties |
|-------------|----------------|----------------------|------|---------------|---|------------------------|----------------|---------------------|--|
| Thread | M4 x 0.7 | KLR-C02-1.0-2.0-K73 | PMMA | 4 mm | 2 x 0.25 mm | 2 m | At least 10 mm | | |
| Thread | M3 x 0.5 | KLR-C04-1.25-2.0-K78 | PMMA | 8 mm | 4 x 0.25 mm | 2 m | At least 15 mm | | |
| Cylindrical | Dia. 2.0 mm | KLR-C02-1.0-2.0-K91 | PMMA | 4 mm | 2 x 0.25 mm | 2 m | At least 10 mm | | |
| Cylindrical | Dia. 3.0 mm | KLR-C02-1.0-2.0-K90 | PMMA | 4 mm | 2 x 0.25 mm | 2 m | At least 10 mm | | |
| Cylindrical | Dia. 1.5 mm | KLR-C04-1.25-2.0-K80 | PMMA | 8 mm | 4 x 0.25 mm | 2 m | At least 15 mm | | |
| Cylindrical | Dia. 1.5 mm | KLR-C04-1.0-2.0-K133 | PMMA | 7 mm | 4 x 0.25 mm | 2 m | At least 15 mm | | |
| Cylindrical | Dia. 2.0 mm | KLR-C02-1.0-2.0-K87 | PMMA | 25 mm | 2 x 0.5 mm | 2 m | At least 15 mm | | |
| Cylindrical | Dia. 3.0 mm | KLR-C04-1.25-2.0-K79 | PMMA | 8 mm | 4 x 0.25 mm | 2 m | At least 15 mm | | |
| Coaxial | | | | | | | | | |
| Thread | M3 x 0.5 | KLR-C09-1.25-2.0-K76 | PMMA | 30 mm | 1 x 0.5 mm emitter 9 x 0.25 mm receiver | 2 m | At least 15 mm | | Only 0.5 mm light spot at 8 mm With auxiliary lens K-LA03 |
| Thread | M4 x 0.7 /M2.6 | KLR-C09-1.25-2.0-K74 | PMMA | 30 mm | 1 x 0.5 mm emitter 9 x 0.25 mm receiver | 2 m | At least 15 mm | | Only 0.7 mm light spot at 10 mm with auxiliary lens K-LA04/ two times higher detection range with auxiliary lens K-LA01/ three times higher detection range with auxiliary lens K-LA06 |
| Thread | M6 x 0.75 | KLR-C16-2.2-2.0-K71 | PMMA | 85 mm | 1 x 1.0 mm emitter 16 x 0.25 mm receiver | 2 m | At least 25 mm | | |

Release date: 2023-04-04 Date of issue: 2023-04-04 Filename: 805077_eng.pdf

| Head type | Mounting | Designation | Core | Sensing range | Fiber cross-section | Length of fiber optics | Bending radius | Dimensional drawing | Special Properties |
|-----------------|-------------|----------------------|------|---------------|---|------------------------|----------------|---------------------|--------------------|
| Cylindrical | Dia. 1.0 mm | KLR-C06-1.25-2.0-K81 | PMMA | 20 mm | 1 x 0.25 mm emitter 6 x 0.25 mm receiver | 2 m | At least 15 mm | | |
| Cylindrical | Dia. 3.0 mm | KLR-C09-1.25-2.0-K77 | PMMA | 30 mm | 1 x 0.5 mm emitter 9 x 0.25 mm receiver | 2 m | At least 15 mm | | |
| Cylindrical | Dia. 5.0 mm | KLR-C16-2.2-2.0-K72 | PMMA | 85 mm | 1 x 1.0 mm emitter 16 x 0.25 mm Receiver | 2 m | At least 25 mm | | |
| Highly flexible | | | | | | | | | |
| Thread | M3 | KHR-C02-1.0-2.0-K96 | PMMA | 12 mm | 2 x 0.5 mm | 2 m | At least 1 mm | | |
| Thread | M4 | KHR-C02-1.0-2.0-K95 | PMMA | 12 mm | 2 x 0.5 mm | 2 m | At least 1 mm | | |
| Thread | M4 | KHR-C02-1.3-2.0-K92 | PMMA | 60 mm | 2 x 1.0 mm | 2 m | At least 2 mm | | |
| Thread | M6 | KHR-C02-2.2-2.0-K94 | PMMA | 12 mm | 2 x 0.5 mm | 2 m | At least 1 mm | | |
| Cylindrical | Dia. 3.0 mm | KHR-C02-1.3-2.0-K93 | PMMA | 60 mm | 2 x 1.0 mm | 2 m | At least 2 mm | | |
| Flexible | | | | | | | | | |
| Thread | M6 x 0.75 | KLR-C02-2.2-2.0-K70 | PMMA | 80 mm | 2 x 1.0 mm | 2 m | At least 25 mm | | |
| Cylindrical | Dia. 3.0 mm | KLR-C02-1.3-2.0-K86 | PMMA | 80 mm | 2 x 1.0 mm | 2 m | At least 25 mm | | |
| Cylindrical | Dia. 5.0 mm | KLR-C02-2.2-2.0-K85 | PMMA | 80 mm | 2 x 1.0 mm | 2 m | At least 25 mm | | |

Release date: 2023-04-04 Date of issue: 2023-04-04 Filename: 805077_eng.pdf

| Head type | Mounting | Designation | Core | Sensing range | Fiber cross-section | Length of fiber optics | Bending radius | Dimensional drawing | Special Properties |
|---------------------------------------|--------------|-----------------------|------|---------------|---------------------|------------------------|----------------|---------------------|--------------------------|
| Flexible tip | | | | | | | | | |
| Thread | M3 x 0.5 | KLR 00-1.0-2.0-K58 | PMMA | 20 mm | | 2 m | At least 15 mm | | |
| Thread | M6 | KLR 00-2.2-2.0-K57 | PMMA | 60 mm | | 2 m | At least 15 mm | | |
| Long detection range | | | | | | | | | |
| Thread | | KLR-C02-2.2-2.0-K146 | PMMA | 150 mm | | 2 m | At least 40 mm | | |
| Thread | | KLR-C10-1.25-2.0-K144 | PMMA | 30 mm | | 2 m | At least 15 mm | | |
| Lateral optical face | | | | | | | | | |
| Thread | M6 | KHR-C02-2.2-2.0-K131 | PMMA | 60 mm | 2 x 1.0 mm | 2 m | At least 2 mm | | Only 2 mm bending radius |
| Thread | Dia. 5.0 mm | KHR-C02-1.0-2.0-K132 | PMMA | 15 mm | 2 x 0.5 mm | 2 m | At least 1 mm | | Only 1 mm bending radius |
| Array | | | | | | | | | |
| Cubic | 3 x M2 x 0.5 | KLR-A18-1.3-2.0-K82 | PMMA | 25 mm | 18 x 0.25 mm | 2 m | At least 25 mm | | |
| Cubic | 3 x M3 x 0.5 | KLR-A32-2.2-2.0-K83 | PMMA | 35 mm | 10.85 mm | 2 m | At least 25 mm | | |
| Cubic | 2 x 3.2 mm | KLR-A32-2.2-2.0-K141 | PMMA | 35 mm | 16 x 0.25 mm | 2 m | At least 25 mm | | |
| Resistant to high temperatures | | | | | | | | | |
| Thread | M6 | KHTR-C02-2.2-2.0-K88 | PMMA | 80 mm | 2 x 1.0 mm | 2 m | At least 25 mm | | - 55 °C ... + 115 °C |

Release date: 2023-04-04 Date of issue: 2023-04-04 Filename: 805077_eng.pdf

| Head type | Mounting | Designation | Core | Sensing range | Fiber cross-section | Length of fiber optics | Bending radius | Dimensional drawing | Special Properties |
|-----------------------|--------------|-----------------------|-------|---------------|---------------------|------------------------|----------------|---------------------|---|
| Cylindrical | Dia. 5.0 mm | KHTR-C02-2.2-2.0-K89 | PMMA | 80 mm | 2 x 1.0 mm | 2 m | At least 25 mm | | -55 °C ... +115 °C |
| Robust design | | | | | | | | | |
| Thread | M3 x 0.5 | LHR 00-0.8-1.0-14M3 | Glass | 40 mm | 0.8 mm | 1 m | 4 mm static | | -40 °C ... +180 °C |
| Thread | M4 x 0.7 | LHR 00-0.8-1.0-20M4 | Glass | 40 mm | 0.8 mm | 1 m | 4 mm static | | -40 °C ... +180 °C |
| Thread | M6 | LHR 00-1.1-1.0-G | Glass | 70 mm | 1.1 mm | 1 m | 4 mm static | | -40 °C ... +180 °C |
| Cylindrical | Dia. 4.5 mm | LHR 00-1.1-1.0-K1 | Glass | 70 mm | 1.1 mm | 1 m | 4 mm static | | -40 °C ... +180 °C |
| Special design | | | | | | | | | |
| Cubic | | KHR-C02-1.0-2.0-K129 | PMMA | 5 ~ 10 mm | 2 x 0.5 mm | 2 m | At least 1 mm | | Crossed light beam for background suppression Only 1 mm bending radius |
| Cubic | | KLR-C02-1.3-2.0-K130 | PMMA | 1 ~ 8 mm | 2 x 1.0 mm | 2 m | At least 25 mm | | Crossed light beam for background suppression |
| Cubic | 3 x M3 x 0.5 | KHR-A02-2.2-2.0-K127 | PMMA | 50 mm | 2 x 1.0 mm | 2 m | At least 2 mm | | Only 2 mm bending radius |
| Cubic | | KLR-C02-1.25-2.0-K128 | PMMA | 4 ~ 26 mm | 2 x 0.5 mm | 2 m | At least 15 mm | | Fill level measurement |
| Cylindrical | | KLR-C02-1.25-2.0-K147 | PMMA | | | 2 m | At least 40 mm | | Fill level detection |

 Using the high-speed mode or glass detection mode halves the detection range.

Release date: 2023-04-04 Date of issue: 2023-04-04 Filename: 805077_eng.pdf