



Fiber optic sensor

SU18-40a/102/115a/123



- Basic line for DIN rail installation
- Sleek design
- 3 response times selectable
- High switching frequency
- External TEACH-IN

Fiber optic sensor for glass fiber optic and plastic fiber optic, slim design, range up to 450 mm, red light, 3 response times available, external Teach-in, light/dark on, 1 NPN output, fixed cable with M8 plug



Dimensions

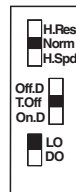
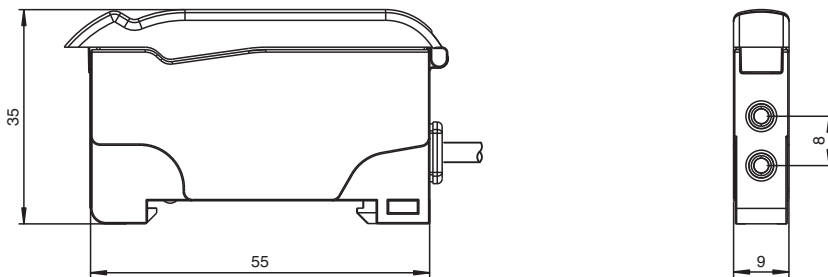

H.Res = High Resolution
 Norm = Normal
 H.Spd = High Speed
 Off.D = Off Delay
 T.Off = Timer off
 On.D = On Delay
 LO = Light on
 DO = Dark on

Technical Data

General specifications	
Sensor range	up to 150 mm (KLR-C02-2,2-2,0-K146)
Detection range	up to 450 mm (KLE-C01-2,2-2,0-K116)
Light source	LED
Light type	modulated visible red light , 660 nm
Ambient light limit	10000 Lux
Functional safety related parameters	
MTTF _d	690 a
Mission Time (T _M)	20 a

Release date: 2023-07-21 Date of issue: 2023-07-21 Filename: 805706_eng.pdf

Technical Data

Diagnostic Coverage (DC)		0 %
Indicators/operating means		
Operation indicator		LED green, statically lit Power on , Undervoltage indicator: Green LED, pulsing (approx. 0.8 Hz) , short-circuit : LED green flashing (approx. 4 Hz)
Function indicator		LED yellow: static illumination switching state, flashes when falling short of the operating reserve
Control elements		Teach-In key slide switch 2 positions: light/dark switching slide switch 3 positions: timer function - timer off, on delay 40 ms, off-delay 40 ms slide switch 3 positions: operating mode - normal, high speed , high resolution
Electrical specifications		
Operating voltage	U_B	10 ... 30 V DC
Ripple		10 %
No-load supply current	I_0	≤ 30 mA
Input		
Function input		external Teach-In
Output		
Stability alarm output		1 NPN, short-circuit protected open collector
Switching type		light/dark on, switchable
Signal output		1 NPN, short-circuit protected open collector
Switching voltage		max. 30 V DC
Switching current		max. 100 mA , resistive load
Voltage drop	U_d	≤ 2 V DC at 100 mA ; ≤ 0.7 V at 10 mA
Switching frequency	f	Standard mode: 3 kHz , High speed mode: 6 kHz , High resolution: 500 Hz
Response time		Standard mode: 160 μs , High speed mode: 80 μs , High resolution: 1 ms
Repeat accuracy	R	≤ 0.5 % of adjusted sensor range
Conformity		
Product standard		EN 60947-5-2
Approvals and certificates		
UL approval		cULus Listed, Class 2 Power Source, Type 1 enclosure
CCC approval		CCC approval / marking not required for products rated ≤36 V
Ambient conditions		
Ambient temperature		-10 ... 55 °C (14 ... 131 °F)
Storage temperature		-20 ... 70 °C (-4 ... 158 °F)
Mechanical specifications		
Housing width		9 mm
Housing height		34.5 mm
Housing depth		62.3 mm
Degree of protection		IP50
Connection		200 mm, PVC cable with M8 connector, 4-pin
Material		
Housing		PC
Mass		45 g

Connection Assignment

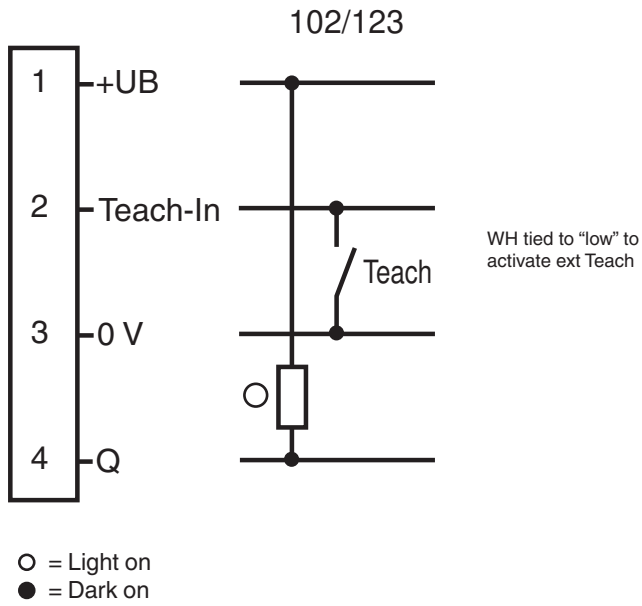

Connection Assignment



Wire colors in accordance with EN 60947-5-2

1	BN	(brown)
2	WH	(white)
3	BU	(blue)
4	BK	(black)

Characteristic Curve

LED indicators and operating chart:

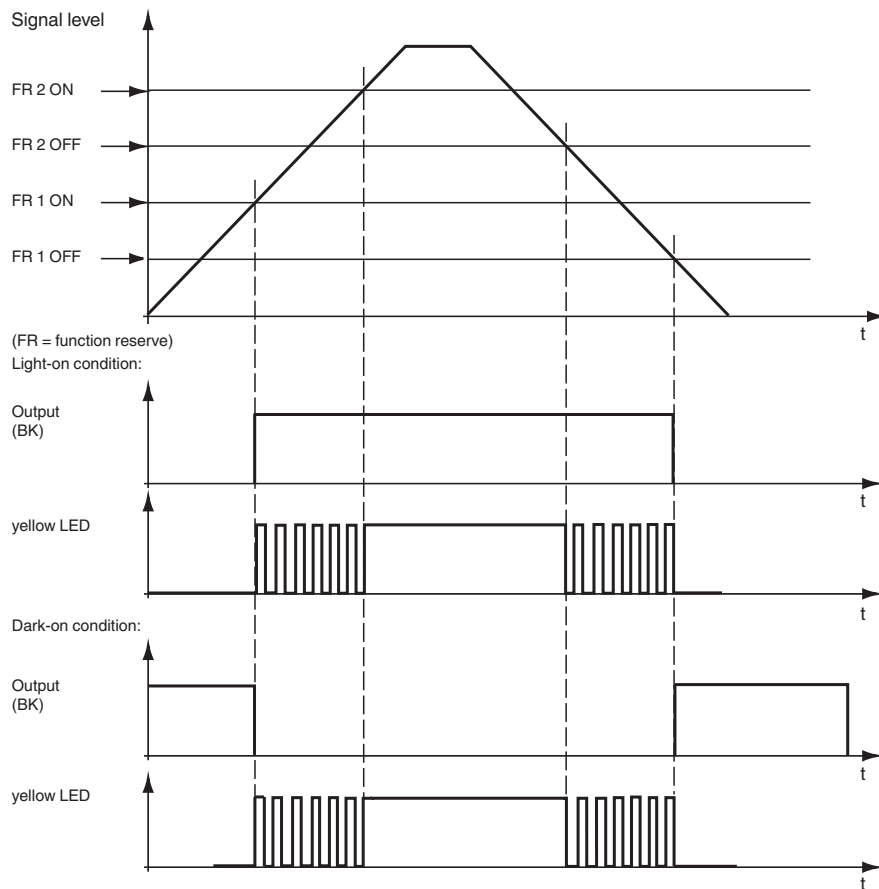











Accessories

	KLR-C02-2,2-2,0-K146	Plastic fiber optic - diffuse
	KLR-C02-2,2-2,0-K70	Plastic fiber optic - diffuse
	KLR-C02-1,0-2,0-K75	Plastic fiber optic - diffuse
	KLR-C09-1,25-2,0-K76	Plastic fiber optic - diffuse
	KLR-C09-1,25-2,0-K74	Plastic fiber optic - diffuse
	KLR-C16-2,2-2,0-K71	Plastic fiber optic - diffuse
	KLR-A32-2,2-2,0-K83	Plastic fiber optic - diffuse
	KHR-C02-2,2-2,0-K131	Plastic fiber optic - diffuse

Release date: 2023-07-21 Date of issue: 2023-07-21 Filename: 805706_eng.pdf

Accessories

	KHTR-C02-2,2-2,0-K88	Plastic fiber optic - diffuse
	KLE-C01-2,2-2,0-K116	Plastic fiber optic - thru-beam
	KLE-C01-2,2-2,0-K103	Plastic fiber optic - thru-beam
	KLE-C01-2,2-2,0-K102	Plastic fiber optic - thru-beam
	KLE-C01-2,2-2,0-K101	Plastic fiber optic - thru-beam
	KLE-C01-2,2-2,0-K113	Plastic fiber optic - thru-beam
	KLE-C01-1,0-2,0-K120	Plastic fiber optic - thru-beam
	KHE-C01-2,2-2,0-K122	Plastic fiber optic - thru-beam
	KHTE-C01-2,2-2,0-K118	Plastic fiber optic - thru-beam
	LHE 00-1,1-1,0-20M4	Glass fiber optic - thru-beam with silicon covering

Teach-In

(for Auto Teach version only):

Dynamic Teach in High Resolution mode:

1. Place a target
2. Press and hold the Teach button for > 2 seconds to enter Teach mode. Both LEDs will indicate fast in phase blinking follow by slow in-phase blinking. If the target is too near (strong signal), the fast blinking will last slightly longer follow by slow blinking
3. Remove target or move target further away from sensor
4. Press and hold the Teach button for < 2 seconds to end Teach mode. Both LEDs will indicate fast in phase blinking and then alternate blinking to signal end of Teach mode

Dynamic Teach in Normal mode:

1. Press and hold the Teach button for > 2 seconds to enter Teach mode. Both LEDs will indicate fast in phase blinking follow by slow in-phase blinking
2. Pass a moving target
3. Press and hold the Teach button for < 2 seconds to end Teach mode. Both LEDs will indicate alternate blinking to signal end of Teach mode

Maximum Teach:

1. Remove target
2. Press and hold the Teach button for > 2 seconds to enter Teach mode. Both LEDs will indicate fast in phase blinking follow by slow in-phase blinking
3. Press and hold the Teach button for > 2 seconds to end Teach mode. Both LEDs will indicate fast in phase blinking and then alternate blinking to signal end of Teach mode

Position Teach:

1. Place a target
2. Press and hold the Teach button for > 2 second to enter Teach mode. Both LEDs will indicate fast in phase blinking follow by slow in-phase blinking. If the target is too near (strong signal), the fast blinking will last slightly longer follow by slow blinking
3. Press and hold the Teach button for > 2 seconds to end Teach mode. Both LEDs will indicate fast in phase blinking and then alternate blinking to signal end of Teach mode

Indications for the Green and Yellow LEDs in detection mode (normal operation):

- Yellow LED is stable ON to indicate that signal received is > FR2
- Yellow LED will flash at 4 Hz to indicate function reserve, $FR1 < \text{signal level} < FR2$
- Green LED stable ON to indicate power supply is ON, sensor is ready.
- Green LED will flash once for each key actuation, e.g., actuation of the Teach button
- Green LED will flash at 4 Hz to indicate a short-circuit fault at the output(s)
- Green LED will flash at 0.8 Hz to indicate an under voltage fault at the power supply

Indications for the Green and Yellow LEDs in the Teach Mode:

- Yellow & Green LEDs in-phase blinking indicates that the sensor has entered the Teach Mode
- Slow Yellow & Green LEDs in-phase blinking indicates that the sensor is ready or it is waiting to learn new information about the target and/or the background
- Fast Yellow & Green LEDs in-phase blinking means that the sensor is in the progress of learning new target. When the learning is complete, slow in-phase blinking will be resumed as before
- Green & Yellow LEDs flash alternately at 8 Hz indicates there has been a Teach fault or Teach error

Remote Teach (Teach by wire)

External Teach in Normal or High Speed mode:

1. Connect the external Teach wire (WH) to either "High" (for push-pull type) or to "Low" (for NPN type) to activate the external Teach mode. Once in the Teach mode, both LED's will indicate fast in-phase blinking followed by slow in-phase blinking.
2. Pass a moving target.
3. Release or disconnect the external Teach wire (WH) to end Teach mode. Both LED's will indicate alternate blinking to signal end of Teach mode. External Teach is now completed.

External Teach in High Resolution mode:

1. Place a target.
2. Connect the external Teach wire (WH) to either "High" (for push-pull type) or to "Low" (for NPN type) to activate the external Teach mode. Once in the Teach mode, both LED's will indicate fast in-phase blinking followed by slow in-phase blinking.
3. Remove target or move target further away from sensor.
4. Release or disconnect the external Teach wire (WH) to end Teach mode. Both LED's will indicate alternate blinking to signal end of Teach mode. External Teach is now completed.

Indications for the Green and Yellow LEDs in detection mode (normal operation):

- Yellow LED is stable ON to indicate that signal received is > FR2

Head shape	Mounting	Model number	Core	Detection distance	Fiber cross section	minimum Object size	Fiber optic length	Bend radius	Dimensions	Special features
Cylindrical	dia. 3 mm	KLE-C01-2.2-2.0-K117	PMMA	400 mm	1.5 mm	0.35 mm	2 m	min. 25 mm		
Side view / Periscope										
Cylindrical	dia. 4.75 mm	KHE-C01-2.2-2.0-K136	PMMA	50 mm	0.5 mm	0.15 mm	2 m	min. 1 mm		only 1 mm Bend radius
Array										
Rectangular	3 x M2 x 0.5	KLE-A16-2.2-2.0-K109	PMMA	100 mm	16 x 0.25 mm	0.05 mm	2 m	min. 25 mm		
Rectangular	3 x M3 x 0.5	KLE-A16-2.2-2.0-K110	PMMA	100 mm	16 x 0.25 mm	0.05 mm	2 m	min. 25 mm		
Rectangular	3 x M3 x 0.5	KLE-A16-2.2-2.0-K111	PMMA	100 mm	16 x 0.25 mm	0.05 mm	2 m	min. 25 mm		
Rectangular	2 x 3.2 mm	KLE-A32-2.2-2.0-K142	PMMA	35 mm	32 x 0.25 mm		2 m	min. 25 mm		
High temperature resistance										
Cylindrical	dia. 3 mm	KHTE-C01-2.2-2.0-K118	PMMA	115 mm	1 mm	0.35 mm	2 m	min. 25 mm		-55°C ... +115 °C
Sturdy design										
Threaded	M3	LHE 00-1.1-1.0-14M3	glass	195 mm	1.1 mm		1 m	4 mm static		-40°C ... +180 °C
Threaded	M4 x 0.7 / M2.6	LHE 00-1.1-1.0-20M4	glass	195 mm	1.1 mm		1 m	4 mm static		4 x high Detection range with Auxiliary lens K-LA01/ 8 x high Detection range with Auxiliary lens K-LA06 Side view / Periscope with K-LA02/ -40°C ... +180 °C
Threaded	M6	LHE 00-1.1-1.0-G	glass	195 mm	1.1 mm		1 m	4 mm static		-40°C ... +180 °C

Release date: 2023-07-21 Date of issue: 2023-07-21 Filename: 805706_eng.pdf

Head type	Mounting	Designation	Core	Sensing range	Fiber cross-section	Length of fiber optics	Bending radius	Dimensional drawing	Special Properties
Thread	M3 x 0.5	KLR-C04-1.25-2.0-K78	PMMA	8 mm	4 x 0.25 m	2 m	At least 15 mm		
Cylindrical	Dia. 2.0 mm	KLR-C02-1.0-2.0-K91	PMMA	4 mm	2 x 0.25 mm	2 m	At least 10 mm		
Cylindrical	Dia. 3.0 mm	KLR-C02-1.0-2.0-K90	PMMA	4 mm	2 x 0.25 mm	2 m	At least 10 mm		
Cylindrical	Dia. 1.5 mm	KLR-C04-1.25-2.0-K80	PMMA	8 mm	4 x 0.25 mm	2 m	At least 15 mm		
Cylindrical	Dia. 1.5 mm	KLR-C04-1.0-2.0-K133	PMMA	7 mm	4 x 0.25 mm	2 m	At least 15 mm		
Cylindrical	Dia. 2.0 mm	KLR-C02-1.0-2.0-K87	PMMA	25 mm	2 x 0.5 mm	2 m	At least 15 mm		
Cylindrical	Dia. 3.0 mm	KLR-C04-1.25-2.0-K79	PMMA	8 mm	4 x 0.25 mm	2 m	At least 15 mm		
Coaxial									
Thread	M3 x 0.5	KLR-C09-1.25-2.0-K76	PMMA	30 mm	1 x 0.5 mm emitter 9 x 0.25 mm receiver	2 m	At least 15 mm		Only 0.5 mm light spot at 8 mm With auxiliary lens K-LA03
Thread	M4 x 0.7 /M2.6	KLR-C09-1.25-2.0-K74	PMMA	30 mm	1 x 0.5 mm emitter 9 x 0.25 mm receiver	2 m	At least 15 mm		Only 0.7 mm light spot at 10 mm with auxiliary lens K-LA04/ two times higher detection range with auxiliary lens K-LA01/ three times higher detection range with auxiliary lens K-LA06
Thread	M6 x 0.75	KLR-C16-2.2-2.0-K71	PMMA	85 mm	1 x 1.0 mm emitter 16 x 0.25 mm receiver	2 m	At least 25 mm		
Cylindrical	Dia. 1.0 mm	KLR-C06-1.25-2.0-K81	PMMA	20 mm	1 x 0.25 mm emitter 6 x 0.25 mm receiver	2 m	At least 15 mm		

Release date: 2023-07-21 Date of issue: 2023-07-21 Filename: 805706_eng.pdf

Head type	Mounting	Designation	Core	Sensing range	Fiber cross-section	Length of fiber optics	Bending radius	Dimensional drawing	Special Properties
Cylindrical	Dia. 3.0 mm	KLR-C09-1.25-2.0-K77	PMMA	30 mm	1 x 0.5 mm emitter 9 x 0.25 mm receiver	2 m	At least 15 mm		
Cylindrical	Dia. 5.0 mm	KLR-C16-2.2-2.0-K72	PMMA	85 mm	1 x 1.0 mm emitter 16 x 0.25 mm Receiver	2 m	At least 25 mm		
Highly flexible									
Thread	M3	KHR-C02-1.0-2.0-K96	PMMA	12 mm	2 x 0.5 mm	2 m	At least 1 mm		
Thread	M4	KHR-C02-1.0-2.0-K95	PMMA	12 mm	2 x 0.5 mm	2 m	At least 1 mm		
Thread	M4	KHR-C02-1.3-2.0-K92	PMMA	60 mm	2 x 1.0 mm	2 m	At least 2 mm		
Thread	M6	KHR-C02-2.2-2.0-K94	PMMA	12 mm	2 x 0.5 mm	2 m	At least 1 mm		
Cylindrical	Dia. 3.0 mm	KHR-C02-1.3-2.0-K93	PMMA	60 mm	2 x 1.0 mm	2 m	At least 2 mm		
Flexible									
Thread	M6 x 0.75	KLR-C02-2.2-2.0-K70	PMMA	80 mm	2 x 1.0 mm	2 m	At least 25 mm		
Cylindrical	Dia. 3.0 mm	KLR-C02-1.3-2.0-K86	PMMA	80 mm	2 x 1.0 mm	2 m	At least 25 mm		
Cylindrical	Dia. 5.0 mm	KLR-C02-2.2-2.0-K85	PMMA	80 mm	2 x 1.0 mm	2 m	At least 25 mm		
Flexible tip									

Release date: 2023-07-21 Date of issue: 2023-07-21 Filename: 805706_eng.pdf

Head type	Mounting	Designation	Core	Sensing range	Fiber cross-section	Length of fiber optics	Bending radius	Dimensional drawing	Special Properties
Thread	M3 x 0.5	KLR 00-1.0-2.0-K58	PMMA	20 mm		2 m	At least 15 mm		
Thread	M6	KLR 00-2.2-2.0-K57	PMMA	60 mm		2 m	At least 15 mm		
Long detection range									
Thread		KLR-C02-2.2-2.0-K146	PMMA	150 mm		2 m	At least 40 mm		
Thread		KLR-C10-1.25-2.0-K144	PMMA	30 mm		2 m	At least 15 mm		
Lateral optical face									
Thread	M6	KHR-C02-2.2-2.0-K131	PMMA	60 mm	2 x 1.0 mm	2 m	At least 2 mm		Only 2 mm bending radius
Thread	Dia. 5.0 mm	KHR-C02-1.0-2.0-K132	PMMA	15 mm	2 x 0.5 mm	2 m	At least 1 mm		Only 1 mm bending radius
Array									
Cubic	3 x M2 x 0.5	KLR-A18-1.3-2.0-K82	PMMA	25 mm	18 x 0.25 mm	2 m	At least 25 mm		
Cubic	3 x M3 x 0.5	KLR-A32-2.2-2.0-K83	PMMA	35 mm	10.85 mm	2 m	At least 25 mm		
Cubic	2 x 3.2 mm	KLR-A32-2.2-2.0-K141	PMMA	35 mm	16 x 0.25 mm	2 m	At least 25 mm		
Resistant to high temperatures									
Thread	M6	KHTR-C02-2.2-2.0-K88	PMMA	80 mm	2 x 1.0 mm	2 m	At least 25 mm		-55 °C ... + 115 °C

Release date: 2023-07-21 Date of issue: 2023-07-21 Filename: 805706_eng.pdf

