

Thru-beam sensor

BB10-P-F2/25/33/35/102/115-7m



- Single-beam miniature photoelectric sensor, ideal for installing in frames or contours
- Integrated circuit
- Plug-in style housing for 13 mm hole
- Narrow opening angle, suitable for mounting in pairs
- Various frequencies for avoiding mutual interference (cross-talk immunity)
- Light on version

Miniature photoelectric sensor with plug-in style housing for mounting in 13 mm hole



Function

There is no simpler way of installing a sensor: drill the hole, clip in the sensor and you're done. What's more, the BB10 plug-in sensors for doors and turnstiles offer top performance at an extremely attractive price. The switching mechanism is integrated in the compact, self-contained and temperature-stable housing, making the BB10 suitable even for extremely cold regions with temperatures as low as -40°C.

Application

- Monitoring function for turnstiles
- Activation function for restarting escalators
- Monitoring of industrial gates
- Person detection for automatic doors and gates

Dimensions

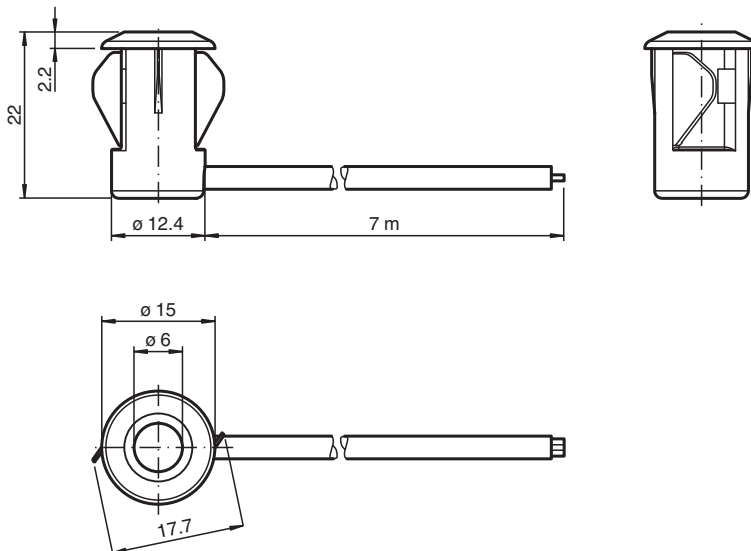

Release date: 2023-05-09 Date of issue: 2023-05-09 Filename: 809336_eng.pdf

Technical Data

System components		
Emitter		BB10-T-F2/33/35/115-7m
Receiver		BB10-R-F2/25/33/35/102/115-7m
General specifications		
Effective detection range		0 ... 3 m
Threshold detection range		4 m
Light source		IRED
Light type		modulated infrared light , 880 nm
Diameter of the light spot		approx. 350 mm at a distance of 3 m
Opening angle		Emitter: +/- 3 ° Receiver: +/- 10 ° at max. sensing range ; typical
Optical face		frontal
Ambient light limit		halogen light 100000 Lux ; according to EN 60947-5-2:2007
Functional safety related parameters		
MTTF _d		795 a
Mission Time (T _M)		20 a
Diagnostic Coverage (DC)		0 %
Indicators/operating means		
Function indicator		LED red: lights up when receiving the light beam ; flashes when falling short of the operating reserve; OFF when light beam is interrupted
Electrical specifications		
Operating voltage	U _B	10 ... 30 V DC
No-load supply current	I ₀	Emitter: ≤ 20 mA Receiver: ≤ 10 mA
Output		
Switching type		light-on
Signal output		1 NPN output, short-circuit protected, reverse polarity protected, open collector
Switching voltage		max. 30 V DC
Switching current		max. 100 mA
Voltage drop	U _d	≤ 1.5 V DC
Switching frequency	f	100 Hz
Response time		5 ms
Conformity		
Product standard		EN 60947-5-2
Approvals and certificates		
CCC approval		CCC approval / marking not required for products rated ≤36 V
UN/ECE Regulation No. 10 (E1)		Type-approval number: 036938
Ambient conditions		
Ambient temperature		-40 ... 60 °C (-40 ... 140 °F) , fixed -20 ... 60 °C (-4 ... 140 °F) , movable
Storage temperature		-40 ... 70 °C (-40 ... 158 °F)
Relative humidity		90 % , noncondensing
Mechanical specifications		
Degree of protection		IP67
Connection		7 m fixed cable Receiver: grey ; Emitter: black
Material		
Housing		PC , black
Optical face		Plastic pane
Mass		approx. 100 g per device

Connection Assignment

Emitter

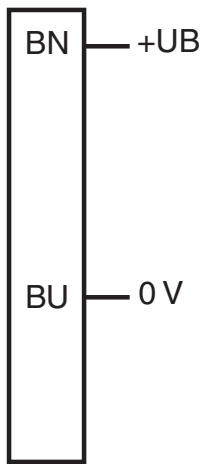

Receiver

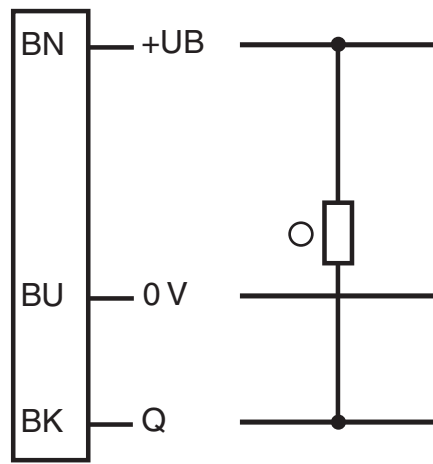

○ = Light on
● = Dark on

Assembly

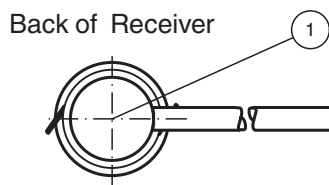

1	Signal display	red
---	----------------	-----

Characteristic Curve

Characteristic response curve

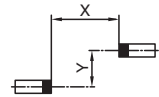
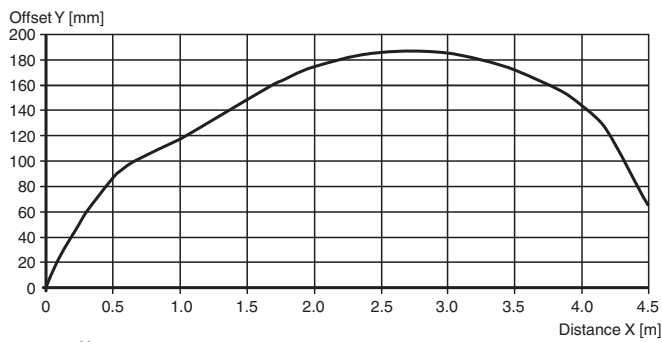

Release date: 2023-05-09 Date of issue: 2023-05-09 Filename: 809336_eng.pdf

Characteristic Curve

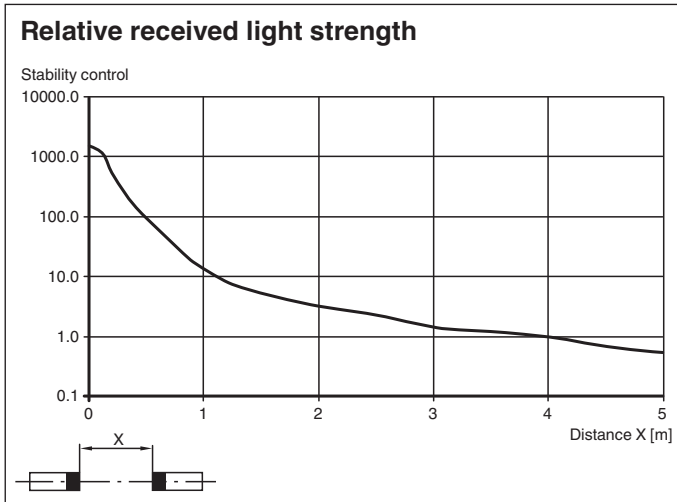

Function Principle

The thru-beam sensor requires two devices for operation; an emitter and a receiver. The emitter and receiver must be optically aligned with one another in a single line. The infrared light emitted from the emitter is recorded by the receiver and evaluated. The sensor detects both people and objects for as long as an object interrupts the detection beam, regardless of movement and surface structure.

Release date: 2023-05-09 Date of issue: 2023-05-09 Filename: 809336_eng.pdf

Additional Information

Static detection:

The sensor detects both people and objects for as long as an object interrupts the detection beam, regardless of movement and surface structure.

		Electronic output
Light ON /25	Person located within beam	Inactive
	No people located within beam	Active
Dark ON /59	Person located within beam	Active
	No people located within beam	Inactive

Optics:

The relatively wide opening angles allow the sensors to be mounted quickly without any alignment issues. Function is maintained even if mounting profiles are slightly distorted.

Mounting:

Thanks to its compact dimensions, the sensor fits in U profiles or behind any covers.

Sheet thickness [mm]	Hole diameter [mm]	
	13	13.5
1	OK	X
2	OK	OK
3	OK	OK

X = mounting not possible

OK = mounting possible

Mounting for dual-beam protection:

For dual-beam versions, two light sources and receivers are required.

When using thru-beam sensors with two different transmission frequencies (F1 and F2), it is not necessary to observe a minimum beam distance between the thru-beam sensors.

When using thru-beam sensors with the same transmission frequency:

Ensure that the minimum beam distance is 20 cm and that the transmitter and receiver are arranged in a cross formation.

