



## Thru-beam sensor (pair) M100/MV100-6090/102/115



- Miniature design
- Slit aperture to shape the light in miniature sensors
- Easy to use
- Very bright, highly visible light spot
- Full metal thread mounting
- Highly visible LEDs for Power ON and switching state
- Not sensitive to ambient light

Thru-beam sensor (pair)



### Function

The optical sensors of this series are suitable for both standard and demanding applications. The series features a miniature housing design, two M3 metal-threaded mounting holes and a highly visible LED status indicator. Each device is equipped with a sensitivity adjuster and a light-on/dark-on changeover switch for increased flexibility. A wide variety of versions are available in both infrared light and red light with PowerBeam for easy alignment. Special versions with BlueBeam are suitable for challenging applications like those in the solar and battery industries.

### Dimensions

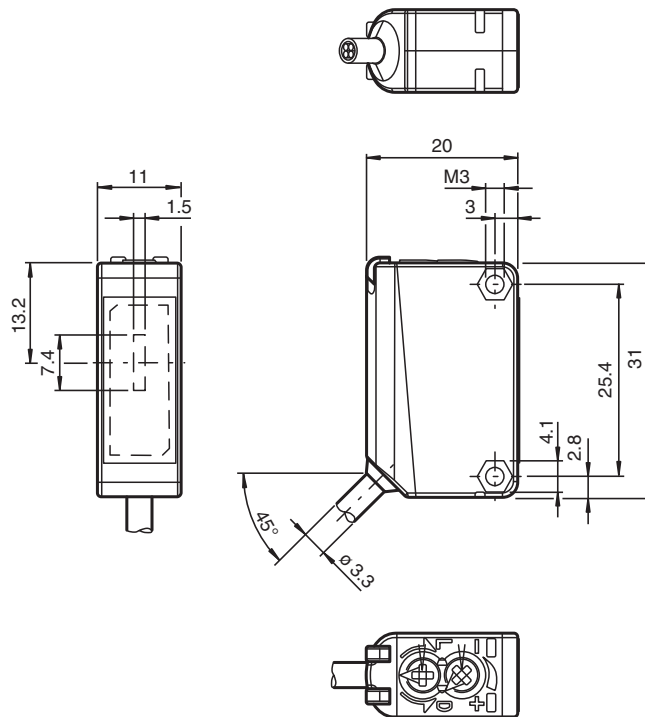

## Technical Data

<b>System components</b>		
Emitter		M100-6090/76b/115
Receiver		MV100-6090/102/115
<b>General specifications</b>		
Effective detection range		0 ... 2.8 m
Threshold detection range		4 m
Light source		LED
Light type		modulated visible red light
Diameter of the light spot		approx. 0.3 m at a distance of 4 m
Opening angle		approx. 2 °
Optical face		frontal
Ambient light limit		EN 60947-5-2
<b>Functional safety related parameters</b>		
MTTF <sub>d</sub>		860 a
Mission Time (T <sub>M</sub> )		20 a
Diagnostic Coverage (DC)		0 %
<b>Indicators/operating means</b>		
Operation indicator		LED green: power on
Function indicator		Receiver: LED yellow, lights up when light beam is free, flashes when falling short of the operating reserve ; OFF when light beam is interrupted
Control elements		sensitivity adjustment
Control elements		Light-on/dark-on changeover switch
<b>Electrical specifications</b>		
Operating voltage	U <sub>B</sub>	10 ... 30 V DC
Ripple		max. 10 %
No-load supply current	I <sub>0</sub>	Emitter: ≤ 15 mA Receiver: ≤ 8 mA
<b>Input</b>		
Test input		emitter deactivation at 0 V
<b>Output</b>		
Switching type		The switching type of the sensor is adjustable. The default setting is: light-on
Signal output		1 NPN output, short-circuit protected, reverse polarity protected, open collector
Switching voltage		max. 30 V DC
Switching current		max. 100 mA , resistive load
Voltage drop	U <sub>d</sub>	≤ 1.5 V DC
Switching frequency	f	1000 Hz
Response time		0.5 ms
<b>Conformity</b>		
Product standard		EN 60947-5-2
<b>Approvals and certificates</b>		
UL approval		cULus Listed, Class 2 Power Source or listed Power Supply with a limited voltage output with (maybe integrated) fuse (max. 3.3 A according UL248), Type 1 enclosure
CCC approval		CCC approval / marking not required for products rated ≤36 V
<b>Ambient conditions</b>		
Ambient temperature		-30 ... 60 °C (-22 ... 140 °F)
Storage temperature		-40 ... 70 °C (-40 ... 158 °F)
<b>Mechanical specifications</b>		
Housing width		11 mm
Housing height		31 mm
Housing depth		20 mm
Degree of protection		IP67
Connection		2 m fixed cable
<b>Material</b>		
Housing		PC (Polycarbonate)

### Technical Data

Optical face	PMMA
Mass	approx. 100 g (emitter and receiver)
Tightening torque, fastening screws	0.6 Nm
Cable length	2 m

### Connection

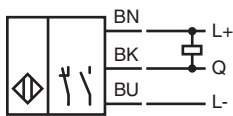
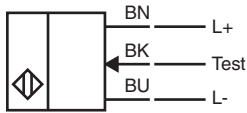

### Assembly

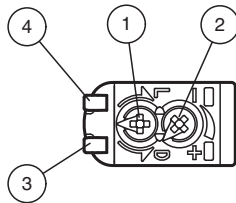

1	Light-Dark-switching	
2	Sensitivity adjuster	
3	Signal display	yellow
4	Operating display	green

### Characteristic Curve

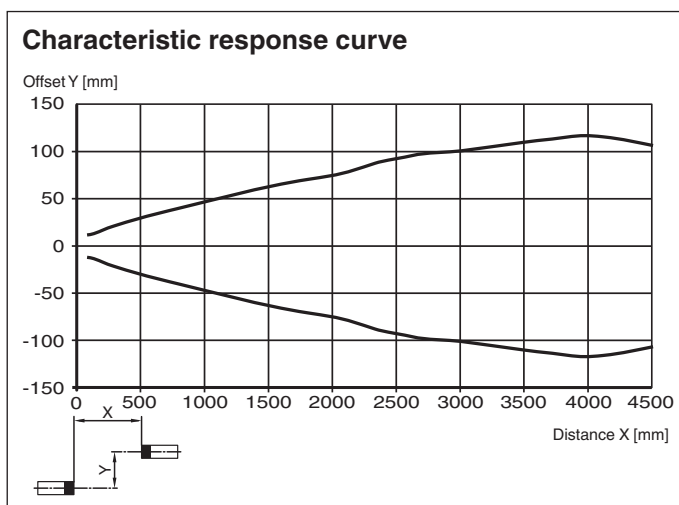





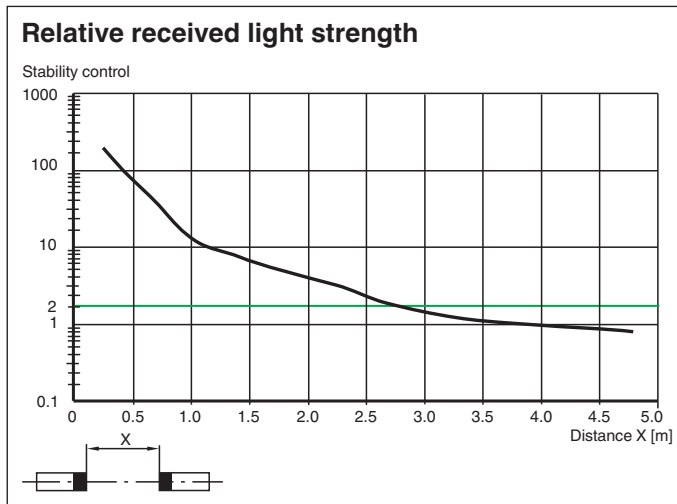





Release date: 2023-03-28 Date of issue: 2023-03-28 Filename: 813889\_eng.pdf

## Characteristic Curve



## Accessories

	<b>OMH-ML100-S2</b>	Mounting aid for ML100 series, mounting bracket
	<b>OMH-ML100-09</b>	Mounting aid for round steel $\varnothing$ 12 mm or sheet 1.5 mm ... 3 mm
	<b>OMH-ML100-01</b>	Mounting aid for ML100 series, mounting bracket
	<b>OMH-ML100-02</b>	Mounting aid for ML100 series, mounting bracket
	<b>OMH-ML100-03</b>	Mounting aid for round steel $\varnothing$ 12 mm or sheet 1.5 mm ... 3 mm
	<b>OMH-ML100-04</b>	Mounting aid for ML100 series, mounting bracket
	<b>OMH-ML100-05</b>	Mounting aid for ML100 series, mounting bracket
	<b>OMH-F10-ML100</b>	Mounting aid for ML100 series
	<b>OMH-10</b>	Mounting aid for ML100 series
	<b>OMH-ML100-S1</b>	Mounting bracket