



Retroreflective sensor with polarization filter



ML100-54/103/115

- Miniature design
- Easy to use
- Clearly visible LEDs for Power ON, switching state and weak signal indication
- Very bright, highly visible light spot
- Full metal thread mounting
- Not sensitive to ambient light

Retroreflective sensor with polarization filter, plastic housing, 5 m detection range, red light, sensitivity adjuster, light/dark on, DC version, PNP output, fixed cable



Function

The optical sensors of this series are suitable for both standard and demanding applications. The series features a miniature housing design, two M3 metal-threaded mounting holes and a highly visible LED status indicator. Each device is equipped with a sensitivity adjuster and a light-on/dark-on changeover switch for increased flexibility. A wide variety of versions are available in both infrared light and red light with PowerBeam for easy alignment. Special versions with BlueBeam are suitable for challenging applications like those in the solar and battery industries.

Dimensions

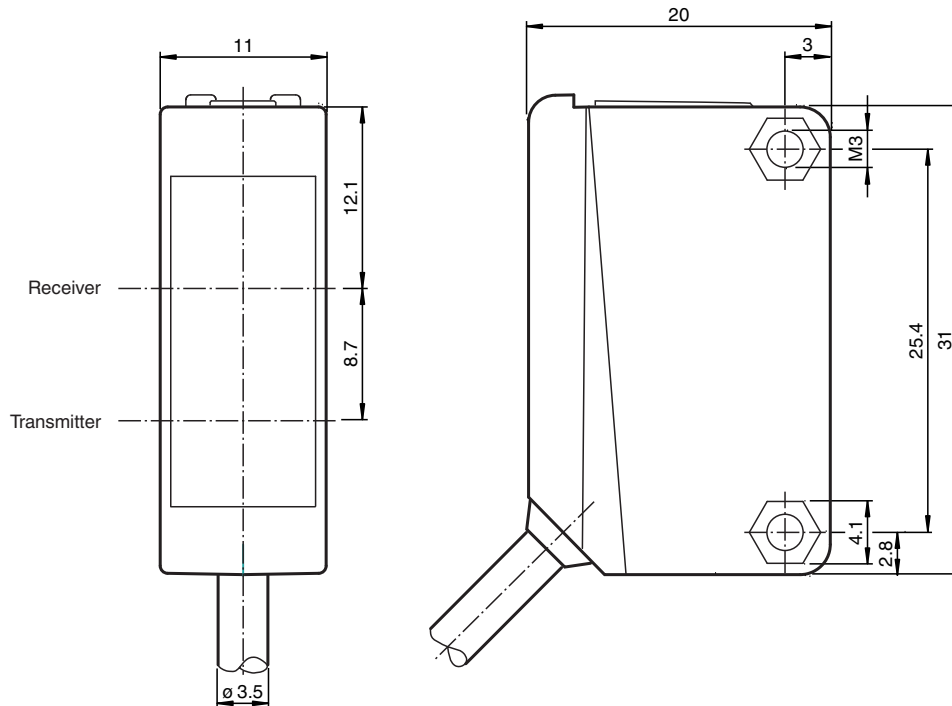

Release date: 2023-03-28 Date of issue: 2023-03-28 Filename: 815461_eng.pdf

Technical Data

General specifications		
Effective detection range		0 ... 3.5 m
Reflector distance		0.01 ... 3.5 m
Threshold detection range		4.5 m
Reference target		H50 reflector
Light source		LED
Light type		modulated visible red light
Polarization filter		yes
Diameter of the light spot		approx. 350 mm at a distance of 4.5 m
Opening angle		approx. 4 °
Optical face		frontal
Ambient light limit		EN 60947-5-2:2007+A1:2012
Functional safety related parameters		
MTTF _d		860 a
Mission Time (T _M)		20 a
Diagnostic Coverage (DC)		0 %
Indicators/operating means		
Operation indicator		LED green: power on
Function indicator		LED yellow: lights up when receiving the light beam ; flashes when falling short of the operating reserve; OFF when light beam is interrupted
Control elements		sensitivity adjustment
Control elements		Light-on/dark-on changeover switch
Electrical specifications		
Operating voltage	U _B	10 ... 30 V DC
Ripple		max. 10 %
No-load supply current	I ₀	< 20 mA
Output		
Switching type		The switching type of the sensor is adjustable. The default setting is: light-on
Signal output		1 PNP output, short-circuit protected, reverse polarity protected, open collector
Switching voltage		max. 30 V DC
Switching current		max. 100 mA , resistive load
Voltage drop	U _d	≤ 1.5 V DC
Switching frequency	f	1000 Hz
Response time		0.5 ms
Conformity		
Product standard		EN 60947-5-2
Approvals and certificates		
UL approval		cULus Listed, Class 2 Power Source or listed Power Supply with a limited voltage output with (maybe integrated) fuse (max. 3.3 A according UL248), Type 1 enclosure
CCC approval		CCC approval / marking not required for products rated ≤36 V
Ambient conditions		
Ambient temperature		-30 ... 60 °C (-22 ... 140 °F)
Storage temperature		-40 ... 70 °C (-40 ... 158 °F)
Mechanical specifications		
Housing width		11 mm
Housing height		31 mm
Housing depth		20 mm
Degree of protection		IP67
Connection		2 m fixed cable
Material		
Housing		PC (Polycarbonate)
Optical face		PMMA
Mass		approx. 50 g
Tightening torque, fastening screws		0.6 Nm

Technical Data

Cable length	2 m
--------------	-----

Connection

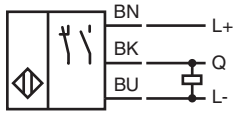

Assembly

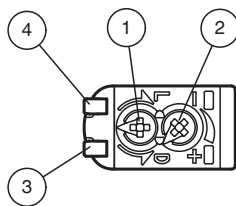

1	Light-Dark-switching	
2	Sensitivity adjuster	
3	Signal display	yellow
4	Operating display	green

Characteristic Curve

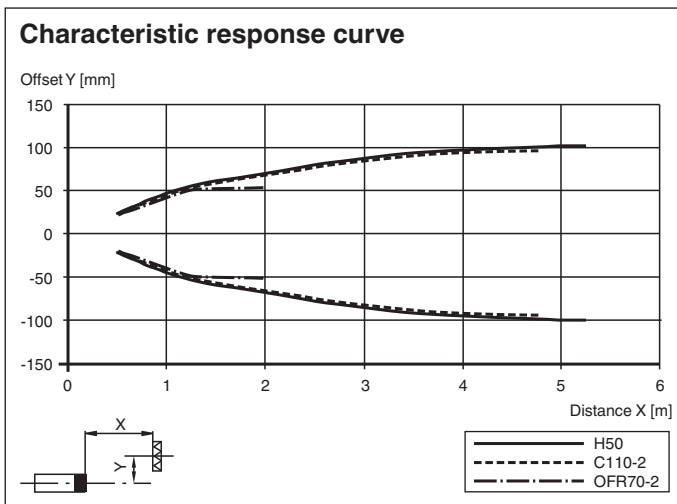

Release date: 2023-03-28 Date of issue: 2023-03-28 Filename: 815461_eng.pdf

Characteristic Curve

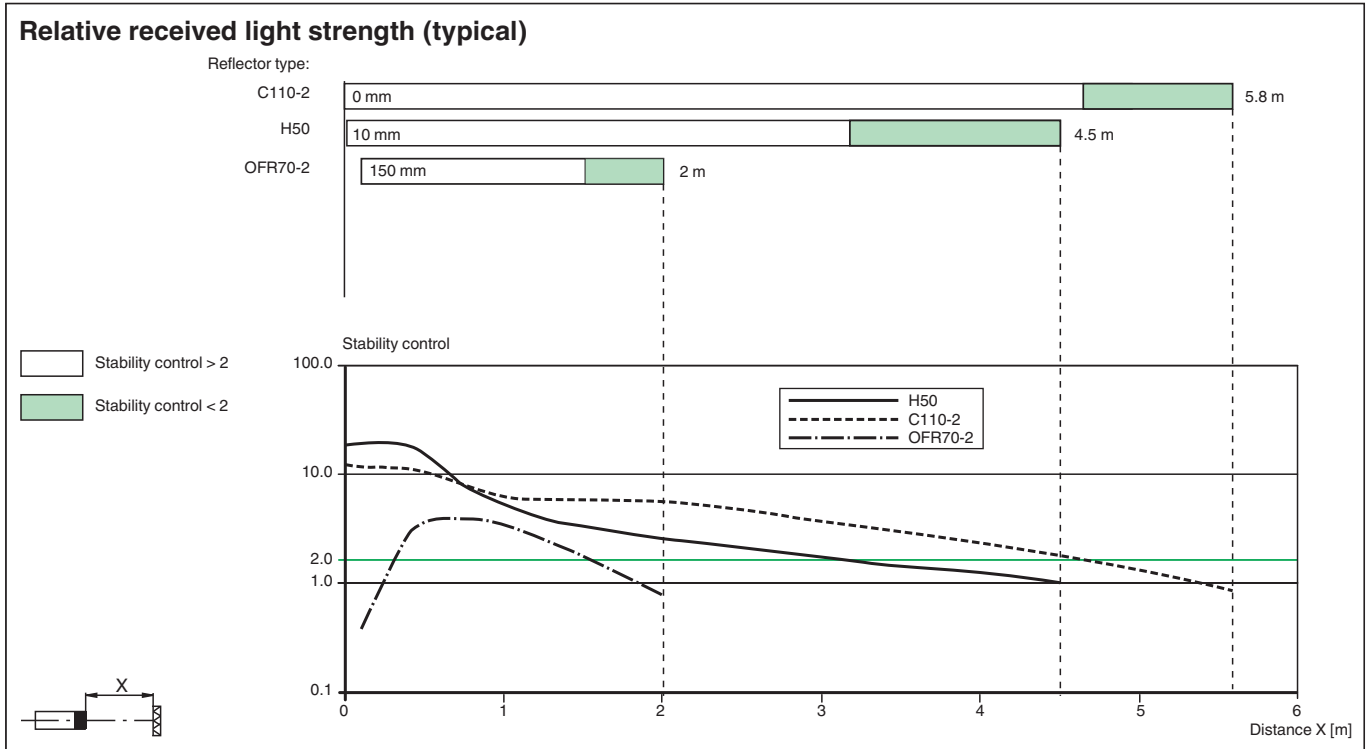





Accessories

	OMH-ML100-09	Mounting aid for round steel \varnothing 12 mm or sheet 1.5 mm ... 3 mm
	OMH-F10-ML100	Mounting aid for ML100 series
	OMH-ML100-01	Mounting aid for ML100 series, mounting bracket
	OMH-ML100-02	Mounting aid for ML100 series, mounting bracket
	OMH-ML100-03	Mounting aid for round steel \varnothing 12 mm or sheet 1.5 mm ... 3 mm
	OMH-ML100-04	Mounting aid for ML100 series, mounting bracket
	OMH-ML100-05	Mounting aid for ML100 series, mounting bracket
	OMH-10	Mounting aid for ML100 series
	REF-C110-2	Reflector, round \varnothing 84 mm, central mounting hole
	REF-H60-2	Reflector with mounting holes
	REF-H33	Reflector with screw fixing

Release date: 2023-03-28 Date of issue: 2023-03-28 Filename: 815461_eng.pdf

Accessories

	OFR-70-2	Reflective tape 70 mm x 70 mm
	REF-MH23-2	Reflector with Micro-structure, rectangular 23 mm x 14 mm, diagonal mounting hole
	REF-H85-2	Reflector, rectangular 84.5 mm x 84.5 mm, mounting holes
	REF-H50	Reflector, rectangular 51 mm x 61 mm, mounting holes, fixing strap
	OFR-100/100	Reflective tape 100 mm x 100 mm