

Inductive sensor NJ2-D-E02-1.250-V1

- 4-wire DC
- Weld Immune
- Sensing range 2 mm
- 3000 psi rating

Cylinder Position Switch



Dimensions

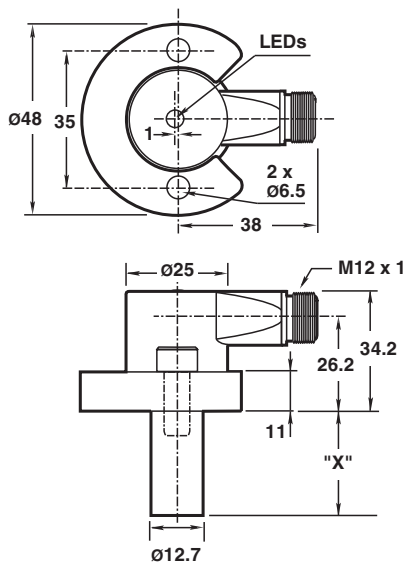

Technical Data

General specifications

Switching function		Normally open (NO)
Output type		PNP/NPN
Rated operating distance	s_n	2 mm
Installation		flush
Output polarity		DC
Assured operating distance	s_a	0 ... 1.62 mm
Reduction factor r_{AI}		0.4
Reduction factor r_{304}		0.85
Output type		4-wire

Release date: 2024-10-17 Date of issue: 2024-10-17 Filename: 904463_eng.pdf

Technical Data

Nominal ratings		
Operating voltage	U_B	10 ... 30 V DC
Switching frequency	f	30 Hz
Hysteresis	H	10 ... 20 % typ. 15 %
Reverse polarity protection		yes
Short-circuit protection		yes
Voltage drop	U_d	≤ 2 V DC
Operating current	I_L	≤ 200 mA
Off-state current	I_r	≤ 100 μ A
No-load supply current	I_0	≤ 35 mA
Mag. Field strength, AC fields		250 mT
Mag. Field strength, DC fields		100 mT
Limit data		
Operating pressure dynamically		3000 psi
Indicators/operating means		
LED green		Power on
LED yellow		Output status
Standard conformity		
Standards		EN 60947-5-2
Approvals and certificates		
UL approval		cULus Listed, General Purpose
Ambient conditions		
Ambient temperature		-25 ... 70 °C (-13 ... 158 °F)
Mechanical specifications		
Connection type		Connector plug
Degree of protection		IP67
Material		Housing: zinc Probe: aluminum
Connector		
Threading		M12 x 1
Number of pins		4
Mass		187 g
Note		X = 1.250 in (31.8 mm)

Connection

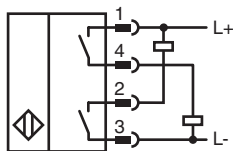

Connection Assignment



Wire colors in accordance with EN 60947-5-2

1	BN	(brown)
2	WH	(white)
3	BU	(blue)
4	BK	(black)

Additional Information

NPT Type Mounting Holes:

1000 and 3000 psi NPT Types:
Mounting hole screw thread shall be 1/4" - 20.

Minimum thread engagement depth is 0.250" (6.35 mm)

Hole spacing is 35 mm center to center.

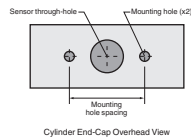

Mounting Screws:

Standard 1000 and 3000 psi models use two, self-locking 1/4" - 20 socket head cap screws (provided).

Recommended tightening torque: 150 in lb (16.95 N-m).



Important: When using spacers, make certain to maintain the 0.250" (6.35 mm) minimum mounting screw thread engagement.