

Inductive sensor

NMB8-30GM55-Z3-C-FE-300MM-V1



- Stainless steel sensing face
- Sensing range 8 mm
- 2-wire DC
- Weld field immune
- Weld slag resistant coating
- Ferrous targets



Dimensions

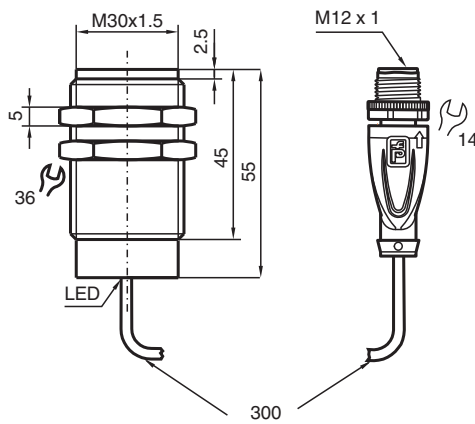

Technical Data

General specifications

Switching function		Normally open (NO)
Output type		Two-wire
Rated operating distance	s_n	8 mm
Installation		flush
Output polarity		DC
Assured operating distance	s_a	0 ... 6.48 mm

Release date: 2025-06-10 Date of issue: 2025-06-10 Filename: 905039_eng.pdf

Technical Data

Actuating element		Ferrous targets
Reduction factor r_{Al}		0
Reduction factor r_{Cu}		0
Reduction factor r_{304}		0.6 - 0.8
Reduction factor r_{S137}		1
Output type		2-wire
Nominal ratings		
Operating voltage	U_B	6 ... 30 V DC
Switching frequency	f	0 ... 5 Hz
Hysteresis	H	3 ... 15 typ. 5 %
Reverse polarity protection		reverse polarity tolerant
Short-circuit protection		no
Voltage drop	U_d	≤ 5.5 V DC
Operating current	I_L	≤ 200 mA
Off-state current	I_r	≤ 0.8 mA
Switching state indicator		LED, red
Mag. Field strength, AC fields		250 mT
Mag. Field strength, DC fields		250 mT
Compliance with standards and directives		
Standard conformity		
Standards		EN IEC 60947-5-2
Approvals and certificates		
UL approval		cULus Listed Circuitry: Class 2 Power Source Enclosure Type Rating: Type 1 Supply/Switching Voltage: 30 V DC Output Switching Current: 200 mA
CCC approval		CCC approval / marking not required for products rated ≤ 36 V
Ambient conditions		
Ambient temperature		-25 ... 70 °C (-13 ... 158 °F)
Mechanical specifications		
Connection type		fixed cable with plug
Housing material		Xylan coated - Stainless steel 1.4305 / AISI 303
Sensing face		Xylan coated - Stainless steel 1.4305 / AISI 303
Degree of protection		IP67 / according to cable specification
Connector		
Threading		M12 x 1
Tightening torque		≤ 0.6 Nm
Number of pins		3
Cable		
Cable diameter		4.8 mm \pm 0.2 mm
Material		POC
Color		orange
Number of cores		4
Core cross section		0.34 mm ²
Length	L	300 mm
Mass		193 g
Dimensions		
Length		55 mm
Diameter		30 mm

Connection

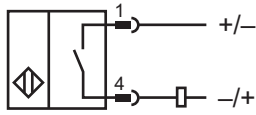

Connection Assignment

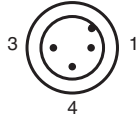

Wire colors in accordance with EN 60947-5-2

1		BN	(brown)
3		BU	(blue)
4		BK	(black)