

Inductive sensor

NJ2-D-US-1.500-V93



- 2-wire AC/DC
- Weld Immune
- Sensing range 2 mm
- 3000 psi rating

Cylinder Position Switch



Dimensions

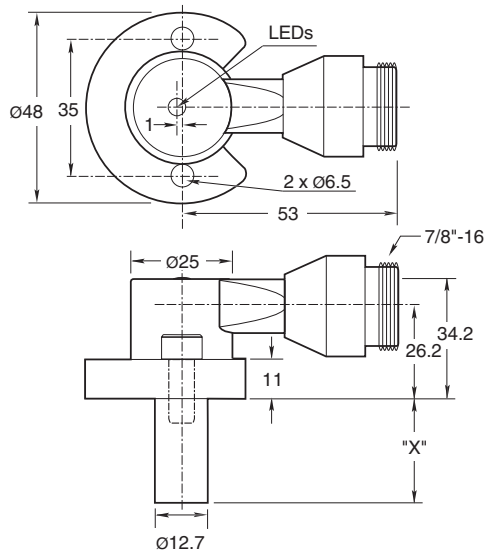

Technical Data

General specifications		
Switching function		Normally open (NO)
Output type		Two-wire
Rated operating distance	s_n	2 mm
Installation		flush
Output polarity		AC/DC
Assured operating distance	s_a	0 ... 1.62 mm
Reduction factor r_{AI}		0.4
Reduction factor r_{304}		0.85
Output type		2-wire
Nominal ratings		
Switching frequency	f	0 ... 20 Hz
Hysteresis	H	10 ... 20 % typ. 15 %

Release date: 2024-10-17 Date of issue: 2024-10-17 Filename: 906590_eng.pdf

Technical Data

Reverse polarity protection		yes
Short-circuit protection		yes
Voltage drop	U_d	$\leq 7 \text{ V}$
Momentary current (20 ms, 0.1 Hz)		max. 3 A
Rated operating current	I_e	8 ... 300 mA AC/DC
Off-state current	I_r	$\leq 1.7 \text{ mA}$
Mag. Field strength, AC fields		250 mT
Mag. Field strength, DC fields		100 mT
Limit data		
Operating pressure dynamically		3000 psi
Indicators/operating means		
LED green		Power on
LED red		Output status
LED red/green		Short circuit/overload indication
Electrical specifications		
Rated operating voltage	U_e	20 ... 250 V AC/DC
Standard conformity		
Standards		EN 60947-5-2
Approvals and certificates		
UL approval		cULus Listed, General Purpose
Ambient conditions		
Ambient temperature		-25 ... 70 °C (-13 ... 158 °F)
Mechanical specifications		
Connection type		Connector plug
Degree of protection		IP67
Material		Housing: zinc Probe: aluminum
Connector		
Threading		7/8 inch-16 UN
Number of pins		3
Mass		200 g
Note		X = 1.50 in (38.1 mm)

Connection

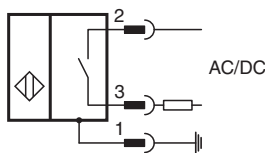

Connection Assignment

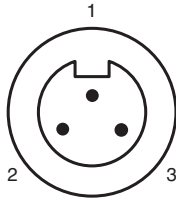

Wire colors

1	GN	(green)
2	BK	(black)
3	WH	(white)

Additional Information

NPT Type Mounting Holes:
 1000 and 3000 psi NPT Types:
 Mounting hole screw thread shall be 1/4" - 20.
 Minimum thread engagement depth is 0.250" (6.35 mm)
 Hole spacing is 35 mm center to center.

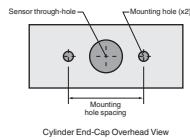

Mounting Screws:
 Standard 1000 and 3000 psi models use two, self-locking 1/4"- 20 socket head cap screws (provided).
 Recommended tightening torque: 150 in lb (16.95 N-m).

⚠ Important: When using spacers, make certain to maintain the 0.250" (6.35 mm) minimum mounting screw thread engagement.

Release date: 2024-10-17 Date of issue: 2024-10-17 Filename: 906590_eng.pdf