

## Inductive sensor NJ2-F-US-2.062-V93

- Weld Immune
- Sensing range 2 mm
- 1000 psi rating
- 2-wire AC/DC

Cylinder Position Switch



### Dimensions

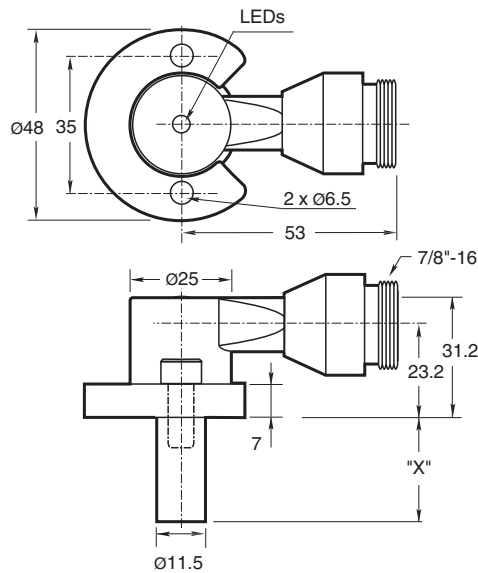

### Technical Data

#### General specifications

Switching function		Normally open (NO)
Output type		Two-wire
Rated operating distance	$s_n$	2 mm
Installation		flush
Output polarity		AC/DC
Assured operating distance	$s_a$	0 ... 1.62 mm
Reduction factor $r_{AI}$		0.4
Reduction factor $r_{304}$		0.85
Output type		2-wire

#### Nominal ratings

Switching frequency	f	0 ... 20 Hz
Hysteresis	H	10 ... 20 % typ. 15 %
Reverse polarity protection		yes
Short-circuit protection		yes
Voltage drop	$U_d$	$\leq 7$ V
Momentary current (20 ms, 0.1 Hz)		max. 3 A

Release date: 2024-10-17 Date of issue: 2024-10-17 Filename: 906610\_eng.pdf

## Technical Data

Rated operating current	$I_e$	8 ... 300 mA AC/DC
Off-state current	$I_r$	< 1.7 mA
Mag. Field strength, AC fields		250 mT
Mag. Field strength, DC fields		100 mT
<b>Limit data</b>		
Operating pressure dynamically		1000 psi
<b>Indicators/operating means</b>		
LED green		Power on
LED red		Output status
LED red/green		Short circuit/overload indication
<b>Electrical specifications</b>		
Rated operating voltage	$U_e$	20 ... 250 V AC/DC
<b>Standard conformity</b>		
Standards		EN 60947-5-2
<b>Approvals and certificates</b>		
UL approval		cULus Listed, General Purpose
<b>Ambient conditions</b>		
Ambient temperature		-25 ... 70 °C (-13 ... 158 °F)
<b>Mechanical specifications</b>		
Connection type		Connector plug
Degree of protection		IP67
Material		Housing: zinc Probe: aluminum
<b>Connector</b>		
Threading		7/8 inch-16 UN
Number of pins		3
Mass		182 g
Note		X = 2.062 in (52.4 mm)

## Connection

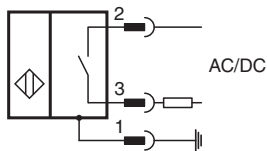

## Connection Assignment

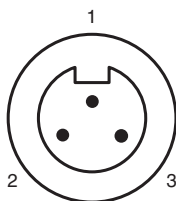

## Connection Assignment

### Wire colors

1		GN	(green)
2		BK	(black)
3		WH	(white)

## Additional Information

### NPT Type Mounting Holes:

1000 and 3000 psi NPT Types:  
Mounting hole screw thread shall be 1/4" - 20.

Minimum thread engagement depth is 0.250" (6.35 mm)

Hole spacing is 35 mm center to center.

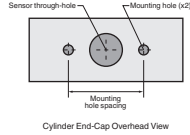

### Mounting Screws:

Standard 1000 and 3000 psi models use two, self-locking 1/4" - 20 socket head cap screws (provided).

Recommended tightening torque: 150 in lb (16.95 N-m).



**Important:** When using spacers, make certain to maintain the 0.250" (6.35 mm) minimum mounting screw thread engagement.