



Model Number

DK50-UV-190/115b/147

Print mark luminescence scanner with fixed cable and M12 connector, 5-pin

Features

- Detect fluorescent chalk marks, clear glue, tamper-proof seals and other marks that regular contrast sensors cannot
- Detect marks on irregular backgrounds
- Sense invisible or nearly invisible marks
- Compact, space-saving construction
- Integral timer available
- Differentiate degrees of luminescent contrast
- Automatic or incremental teach

Dimensions

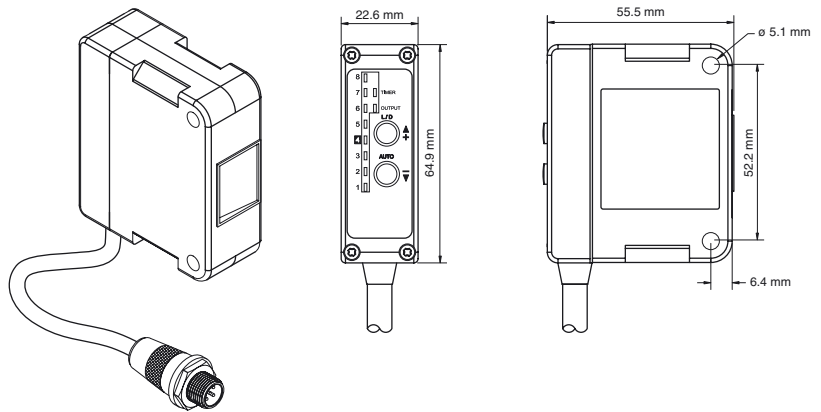

Electrical connection

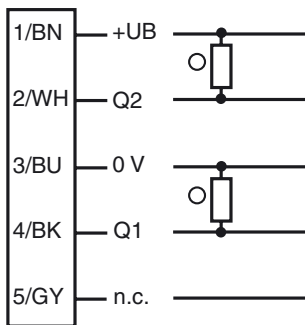

○ = Light on
● = Dark on

Pinout

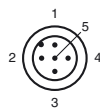

Wire colors in accordance with EN 60947-5-2

- | | | |
|---|----|---------|
| 1 | BN | (brown) |
| 2 | WH | (white) |
| 3 | BU | (blue) |
| 4 | BK | (black) |
| 5 | GY | (gray) |

ase date: 2017-07-26 14:31 Date of issue: 2017-07-26 912568_eng.xml

Technical data**General specifications**

Detection range	0 ... 190 mm
Light source	LED
Light type	modulated UV light
Light spot representation	2.2 mm at 25.4 mm sensor range
Teach-In	Incremental or automatic

Indicators/operating means

Operation indicator	LED green, 15 ms off delay timer LED green (x8), for contrast level indication
Function indicator	LED red, lights up with receiver lit
Teach-In indicator	Automatic Teach-In: green contrast LEDs turn on and off once from levels 1 through 8 then level 8 LED flashes twice Incremental Teach-In: green contrast level LED position may change
Control elements	Push buttons for automatic or incremental Teach-In, L.O./D.O. mode, and/or off-delay timer

Electrical specifications

Operating voltage	U_B	10 ... 30 V DC
No-load supply current	I_0	50 mA

Output

Switching type	light on / dark on	
Signal output	1 PNP and 1 NPN short-circuit protected, reverse polarity protected	
Switching voltage	max. 30 V DC	
Switching current	150 mA	
Switching frequency	f	2.5 kHz
Response time	200 μ s	

Ambient conditions

Ambient temperature	-15 ... 70 °C (5 ... 158 °F)
Storage temperature	-15 ... 70 °C (5 ... 158 °F)

Mechanical specifications

Housing width	22.9 mm
Housing height	64.9 mm
Housing depth	56 mm
Degree of protection	IP67
Connection	152.4 mm fixed cable with 5-pin, M12 x 1 connector
Material	
Housing	Polycarbonate
Optical face	Acrylic
Mass	91 g

Approvals and certificates

UL approval	cULus
Approvals	CE, cULus

Function description**Adjustment****Automatic Teach**

- 1) Position the sensor so that its effective ultraviolet (UV) light beam is focused on the luminescent target. The target should glow when excited by UV light.
- 2) Push the AUTO button. The contrast indicator LED next to "8" will illuminate. Completely remove the luminescent target from the sensor's light beam. The contrast indicator LED must fall to a minimum level of "3" or lower. The high indication of "8" vs. the low indication of "3" (or below) designates the recommended contrast deviation below.

A minimum contrast deviation of 7 is recommended to provide a reasonable operating margin. If the signal level fails to reach "7" or "8" after an automatic teach, it is recommended to adjust the sensor's position relative to the target and repeat the automatic teach. It may be necessary to adjust the sensor position toward and away from the target to determine the position that achieves the maximum signal level on the contrast indicator.

Incremental Teach

- 1) Position the sensor so that its effective ultraviolet (UV) light beam is focused on the luminescent target. The target should glow when excited by UV light.

Accessories**OMH-DK50**

Right-Angled Mounting Bracket

V15-G-2M-PUR

Female cordset, M12, 5-pin, PUR cable

Other suitable accessories can be found at www.pepperl-fuchs.com

- 2) Press "+" button quickly one or more times to manually increase the sensitivity of the sensor, and/or press "-" button quickly one or more times to manually decrease the sensitivity of the sensor.

Timer Mode

Push and hold both push-buttons simultaneously to turn on or off the integral 15 ms pulse-stretching timer. The green LED next to TIMER is on when the timer is active and is off when there is no timer function.

Setting Light On / Dark On Mode

Press and hold the L/D button for 2 seconds to toggle between Light on and Dark on modes. The red LED next to OUTPUT changes state when the mode switches.

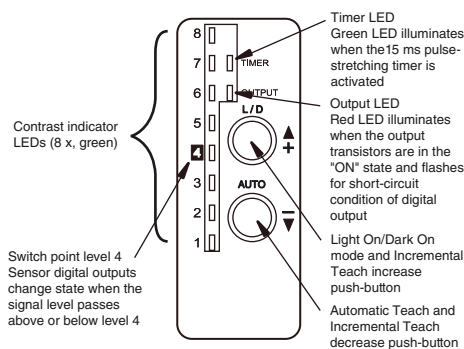

Figure 1. Push-buttons and Status Indication LEDs

Note on Sensing Range Specification

Sensing range specifications are typical values and are dependent on application conditions, the luminescent concentration, and other attributes of the target. It is suggested to test the sensor model in the application to ensure optimal performance.