



Model Number

DK50-UV-330/79d/115b/147

Print mark luminescence scanner with fixed cable and M12 connector, 5-pin

Features

- Detect fluorescent chalk marks, clear glue, tamper-proof seals and other marks that regular contrast sensors cannot
- Detect marks on irregular back-grounds
- Sense invisible or nearly invisible marks
- Compact, space-saving construction
- Integral timer available
- Differentiate degrees of luminescent contrast
- Automatic or incremental teach

Dimensions

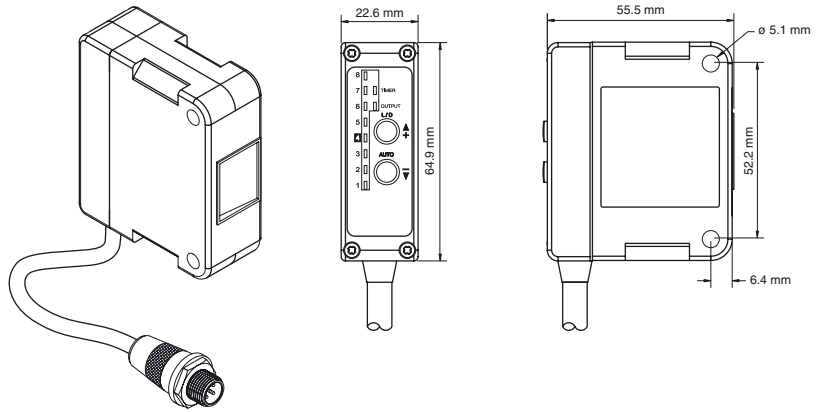

Electrical connection

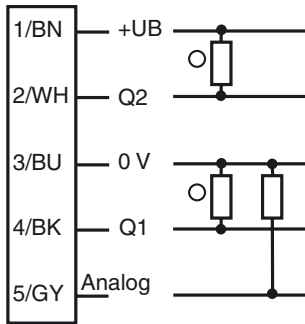

○ = Light on
● = Dark on

Pinout

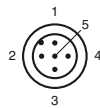

Wire colors in accordance with EN 60947-5-2

- 1 | BN (brown)
- 2 | WH (white)
- 3 | BU (blue)
- 4 | BK (black)
- 5 | GY (gray)

ase date: 2017-07-26 14:31 Date of issue: 2017-07-26 912573_eng.xml

Technical data**General specifications**

Detection range	0 ... 330 mm
Light source	LED
Light type	modulated UV light
Light spot representation	4.1 mm at 101.6 mm sensor range
Teach-In	Incremental or automatic

Indicators/operating means

Operation indicator	LED green, 15 ms off delay timer LED green (x8), for contrast level indication
Function indicator	LED red, lights up with receiver lit
Teach-In indicator	Automatic Teach-In: green contrast LEDs turn on and off once from levels 1 through 8 then level 8 LED flashes twice Incremental Teach-In: green contrast level LED position may change
Control elements	Push buttons for automatic or incremental Teach-In, L.O./D.O. mode, and/or off-delay timer

Electrical specifications

Operating voltage	U_B	10 ... 30 V DC
No-load supply current	I_0	50 mA

Output

Switching type	light on / dark on
Signal output	1 PNP and 1 NPN short-circuit protected, reverse polarity protected
Switching voltage	max. 30 V DC
Switching current	150 mA
Measurement output	0 - 5 V DC $R_{min} = 1 \text{ k}\Omega$
Switching frequency	f 2.5 kHz
Response time	Discrete Output 200 μ s Analog output 1 ms

Ambient conditions

Ambient temperature	-15 ... 60 °C (5 ... 140 °F)
Storage temperature	-15 ... 70 °C (5 ... 158 °F)

Mechanical specifications

Housing width	22.9 mm
Housing height	64.9 mm
Housing depth	56 mm
Degree of protection	IP67
Connection	152.4 mm fixed cable with 5-pin, M12 x 1 connector
Material	
Housing	Polycarbonate
Optical face	Acrylic
Mass	91 g

Approvals and certificates

Approvals	CE, cULus
-----------	-----------

Function description**Adjustment****Automatic Teach**

- 1) Position the sensor so that its effective ultraviolet (UV) light beam is focused on the luminescent target. The target should glow when excited by UV light.

Accessories**OMH-DK50**

Right-Angled Mounting Bracket

V15-G-2M-PUR

Female cordset, M12, 5-pin, PUR cable

Other suitable accessories can be found at www.pepperl-fuchs.com

2) While pressing the AUTO button, repeatedly press the "+" button to scroll through the four possible automatic teach modes. The direction of the flashing contrast indicator LEDs (numbered 1 through 8) indicates the current automatic teach mode (see Figure 1). When the desired mode is indicated, release the AUTO button. Descriptions of the four automatic teach modes are below.

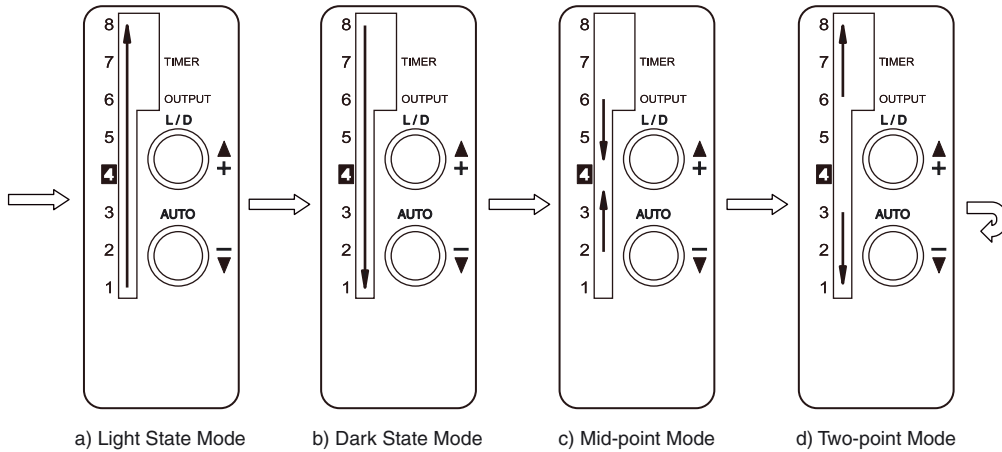

Figure 1. LED flashing sequence for automatic teach modes

a) Light State mode

- The most luminescent target should be in view of the sensor when the AUTO button is released.
- This mode sets the sensor's digital output threshold approximately 10% below the sampled point. The contrast indicator LEDs display the level of returned light relative to the threshold.

b) Dark State mode

- The least luminescent target should be in view of the sensor when the AUTO button is released.
- This mode sets the sensor's digital output threshold approximately 10% above the sampled point. The contrast indicator LEDs display the level of returned light relative to the threshold.

c) Mid-point mode

- The luminescent target should be in view of the sensor when the AUTO button is released to center the analog output.
- This mode sets the sensor's digital output threshold at the sampled point (the middle of the hysteresis band). The contrast indicator LEDs display the level of returned light relative to the threshold.

d) Two-point mode

- The luminescent target that should turn ON the digital output should be in view of the sensor when the AUTO button is released. Then the target that should not turn ON the digital output should be placed in view of the sensor, and the AUTO button should again be pressed and released. (Note: Insufficient contrast is indicated by all eight contrast indicator LEDs flashing three times.)
- This mode sets the sensor's threshold midway between the two sampled points. The contrast indicator LEDs display the level of returned light relative to the threshold. The contrast indicator LEDs are scaled to the application from level 0 to level 8 based on the two set points.

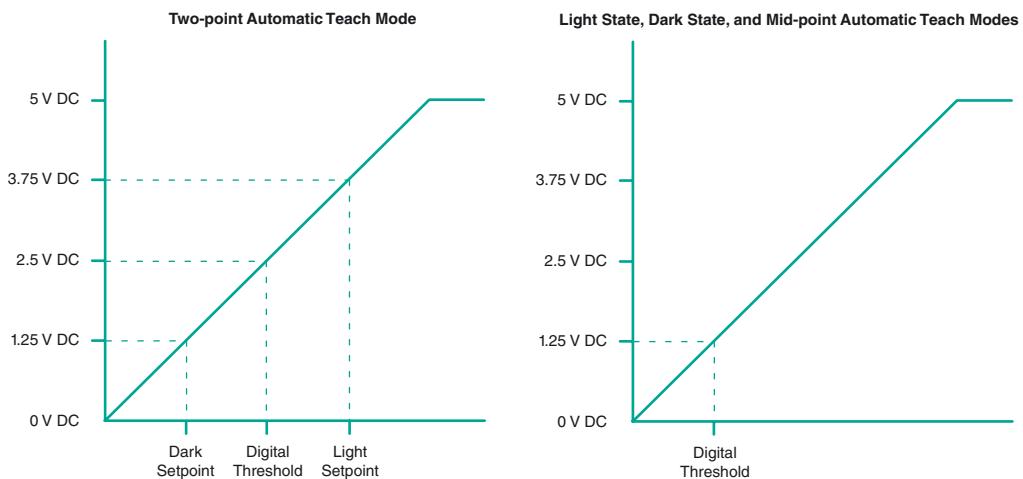

Figure 2. Digital Output Thresholds for Automatic Teach Modes

ase date: 2017-07-26 14:31 Date of issue: 2017-07-26 912573_eng.xml

Incremental Teach

- 1) Position the sensor so that its effective ultraviolet (UV) light beam is focused on the luminescent target. The target should glow when excited by UV light.
- 2) Press "+" button quickly one or more times to manually increase the sensitivity of the sensor, and/or press "-" button quickly one or more times to manually decrease the sensitivity of the sensor.

Timer Mode

Push and hold both push-buttons simultaneously to turn on or off the integral 15 ms pulse-stretching timer. The green LED next to TIMER is on when the timer is active and is off when there is no timer function.

Setting Light On / Dark On Mode

Press and hold the L/D button for 2 seconds to toggle between Light on and Dark on modes. The red LED next to OUTPUT changes state when the mode switches.

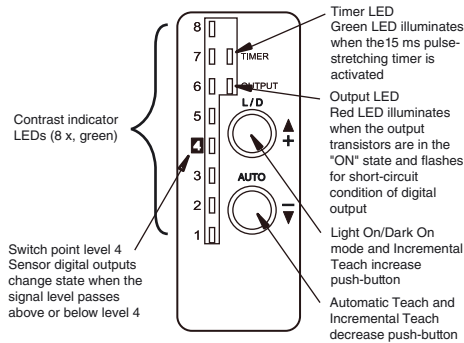

Figure 3. Push-buttons and Status Indication LEDs

Note on Sensing Range Specification

Sensing range specifications are typical values and are dependent on application conditions, the luminescent concentration, and other attributes of the target. It is suggested to test the sensor model in the application to ensure optimal performance.