

Multiturn absolute encoder ESM58-PZ

- Industrial standard housing Ø58 mm
- Ethernet interface with Powerlink
- 30 Bit multiturn
- Two Ethernet connectors with built in hub
- Recessed hollow shaft



Function

Absolute rotary encoders deliver an absolute step value for each angle setting. On account of the high number of measuring steps, this type of absolute rotary encoder can be used to divide very long linear distances into small measuring steps.

The Ethernet interface of this absolute encoder supports the Powerlink V2 protocol. An integrated hub allows wiring in a line structure (daisy chain).

In addition to various functions like resolution adjustment, rotation direction, node number setting or limit switch adjustment, the following operation modes can be selected:

- Polled mode
- Multiplexed mode
- Poll Response chaining

The absolute encoder is mounted directly onto the application shaft, without any coupling. Rotation of the absolute encoder is prevented by a torque rest.

Dimensions

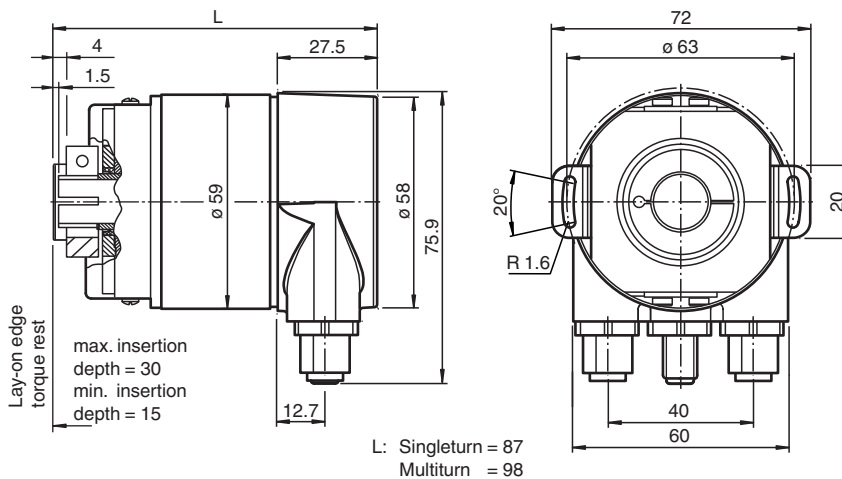

Technical Data

General specifications

Detection type	photoelectric sampling
Device type	Multiturn absolute encoder

Functional safety related parameters

MTTF _d	120 a
Mission Time (T _M)	20 a
L _{10h}	1.9 E+11 at 6000 rpm and 20/40 N axial/radial shaft load

Release date: 2022-12-12 Date of issue: 2022-12-12 Filename: t163533_eng.pdf









Technical Data

Diagnostic Coverage (DC)	0 %	
Electrical specifications		
Operating voltage	U_B	10 ... 30 V DC , safe galvanic isolation per EN 50178
Power consumption	P_0	max. 3 W
Linearity	± 0.5 LSB (12 Bit) , ± 2 LSB (16 Bit)	
Output code	binary code	
Code course (counting direction)	programmable, cw ascending (clockwise rotation, code course ascending) cw descending (clockwise rotation, code course descending)	
Interface		
Interface type	Ethernet Powerlink	
Resolution		
Single turn	up to 16 Bit	
Multiturn	14 Bit	
Overall resolution	up to 30 Bit	
Physical	Ethernet	
Transfer rate	100 MBit/s	
Connection		
Connector	Ethernet: 2 sockets M12 x 1, 4-pin, D-coded Supply: 1 plug M12 x 1, 5-pin, A-coded	
Standard conformity		
Degree of protection	DIN EN 60529, shaft side: IP64 (without shaft seal)/IP66 (with shaft seal) housing side: IP65	
Climatic testing	DIN EN 60068-2-3, no moisture condensation	
Emitted interference	EN 61000-6-4:2007	
Noise immunity	EN 61000-6-2:2005	
Shock resistance	DIN EN 60068-2-27, 100 g, 6 ms	
Vibration resistance	DIN EN 60068-2-6, 10 g, 10 ... 2000 Hz	
Approvals and certificates		
UL approval	cULus Listed, General Purpose, Class 2 Power Source	
CCC approval	CCC approval / marking not required for products rated ≤ 36 V	
Ambient conditions		
Operating temperature	-40 ... 79 °C (-40 ... 174.2 °F)	
Storage temperature	-40 ... 85 °C (-40 ... 185 °F)	
Relative humidity	98 % , no moisture condensation	
Mechanical specifications		
Material	housing: powder coated aluminum flange: aluminum shaft: stainless steel	
Mass	approx. 700 g	
Rotational speed	max. 12000 min ⁻¹	
Moment of inertia	30 gcm ²	
Starting torque	≤ 3 Ncm (version without shaft seal)	
Tightening torque, fastening screws	max. 1.8 Nm	
Shaft load		
Angle offset	$\pm 0.9^\circ$	
Axial offset	static: ± 0.3 mm, dynamic: ± 0.1 mm	
Radial offset	static: ± 0.5 mm, dynamic: ± 0.2 mm	

Accessories

	V15-G-YE2M-PVC	Female cordset, M12, 5-pin, PVC cable
---	-----------------------	---------------------------------------

Accessories

	V15-G-YE5M-PVC	Female cordset, M12, 5-pin, PVC cable
	V1SD-G-ABG-PG9	Male connector M12 straight D-coded 4-pin, for cable diameter 5 - 8 mm, shielded, field-attachable
	V1SD-G-2M-PUR-ABG-V45-G	Connection cable, M12 to RJ-45, PUR cable 4-pin, CAT5e
	V15-G-PG9	Female connector M12 straight A-coded 5-pin, for cable diameter 6 - 8 mm, field-attachable
	ACC-PACK-ABS-_S_58 ø15	Accessories set for Ø58 absolut rotary encoder with recessed hollow shaft 15 mm
	ACC-PACK-ABS-_S_58 ø14	Accessories set for Ø58 absolut rotary encoder with recessed hollow shaft 14 mm
	ACC-PACK-ABS-_S_58 ø12	Accessories set for Ø58 absolut rotary encoder with recessed hollow shaft 12 mm
	ACC-PACK-ABS-_S_58 ø10	Accessories set for Ø58 absolut rotary encoder with recessed hollow shaft 10 mm

Connection

Pin	Male connector M12 x 1, 4-pin, A-coded	Female connector M12 x 1, 4-pin, D-coded
1	Supply voltage +U _B	Tx +
2	-	Rx +
3	0 V	Tx -
4	-	Rx -

--	--

Indication

LEDs for HUB Port

LED	Color	Status	Meaning
LS/DA 1	green	on	LINK active for HUB Port 1
		blinking	Activity on HUB Port 1
LS/DA 2	green	on	LINK active for HUB Port 2
		blinking	Activity on HUB Port 2

LEDs for Powerlink

LED	Color	Status	Meaning
Error	red	on	- not allowed node number - internal communication error - buffer underrun/overflow - collision - CRC error - loss of SoC
		off	no error
Status	green	off	not active
		flickering	Basic Ethernet mode
		flashes 1x	Pre-Operational 1
		flashes 2x	Pre-Operational 2
		flashes 3x	ready to operate
		on	Operational
		blinking	Stopped

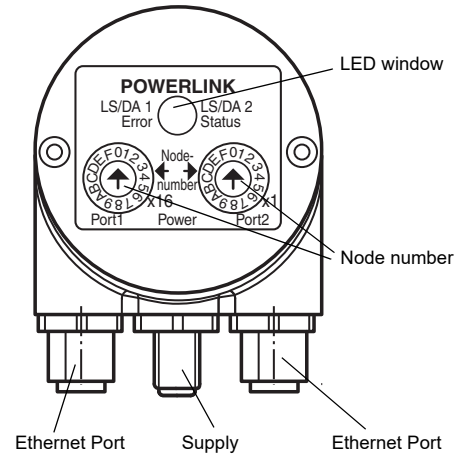

Node number adjustment

The setting of the controlled node number is achieved by 2 hexadecimal switches x16 and x1. Allowed node numbers range is 1 ... 239. The adjusted node number is calculated as follows:
 Node number = Decimal value_[switch x16] x 16 + Decimal value_[switch x1] x 1

Example:

[switch x16] = A, [switch x1] = 5
 A_{hex} = 10_{dec} x 16 = 160 + 5 = 165

Type Code

Release date: 2022-12-12 Date of issue: 2022-12-12 Filename: t163533_eng.pdf

Order code

E S M 5 8 N - P Z R 0 B N -

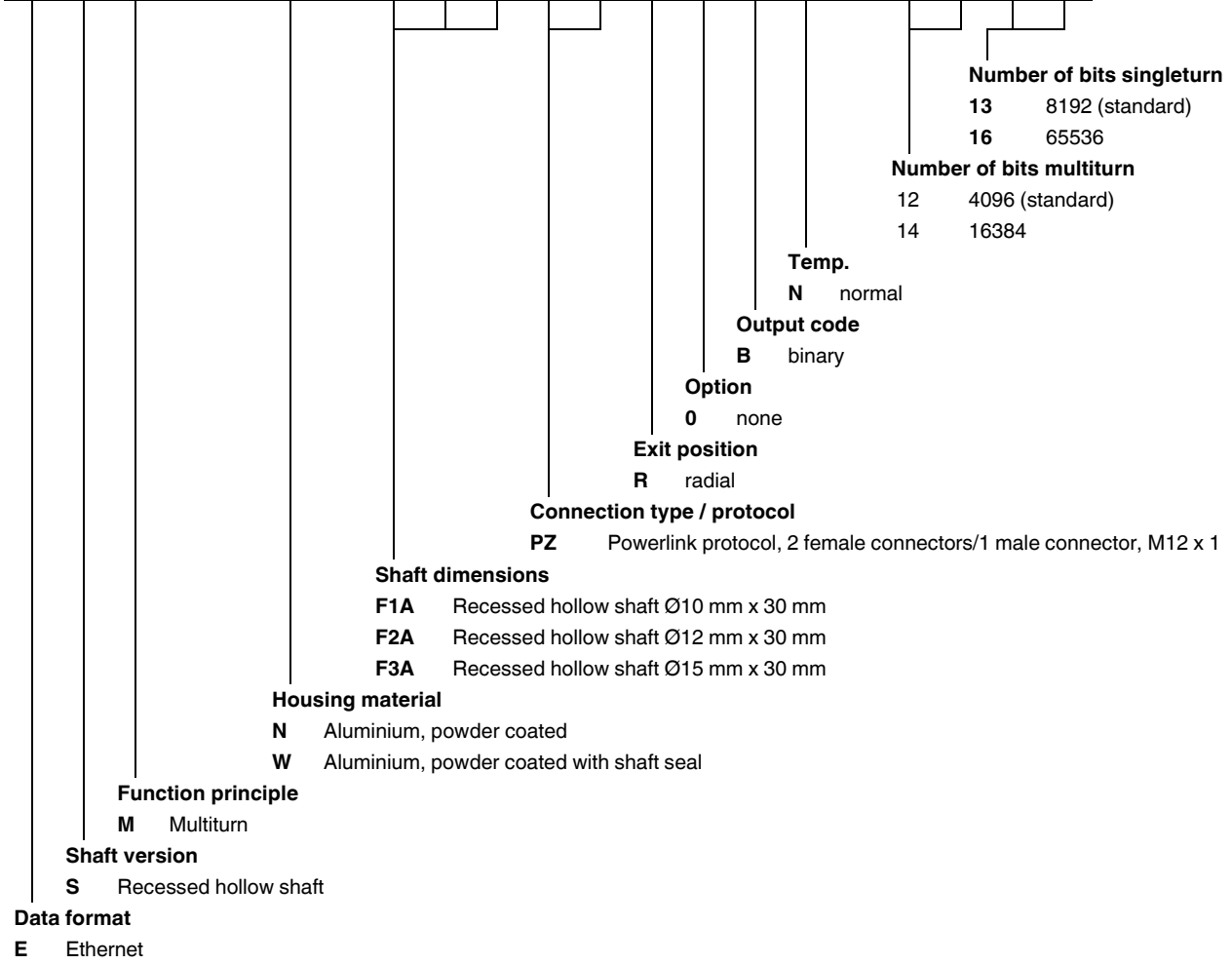

Release date: 2022-12-12 Date of issue: 2022-12-12 Filename: t163533_eng.pdf