



Singleturn absolute encoder DVS58

- Industrial standard housing Ø58 mm
- 16 Bit singleturn
- Galvanically isolated DeviceNet interface
- Servo or clamping flange



Function

Absolute encoders deliver an absolute step value for each angle setting. All these values are represented by code samples of one or more code disks. The code disks are screened by an infrared LED and the bit obtained sample is detected by means of an optical array. Its signals are electronically amplified and are forwarded on to the interface for processing.

The absolute encoder has a maximum basic resolution of 65536 steps per revolution (16 Bits).

The integrated CAN bus interface of the absolute encoder supports all DeviceNet functions. The following operating modes can be programmed, and can selectively be turned on or off:

- Polled mode
- Cyclic mode
- Change of state mode

The device is designed for shaft mounting and is available in servo flange or clamping flange design.

The bus electronics module is integrated into the removable housing cover. This makes it possible to mount or replace the new rotary encoders and the matching bus electronics separately during installation or service.

Dimensions

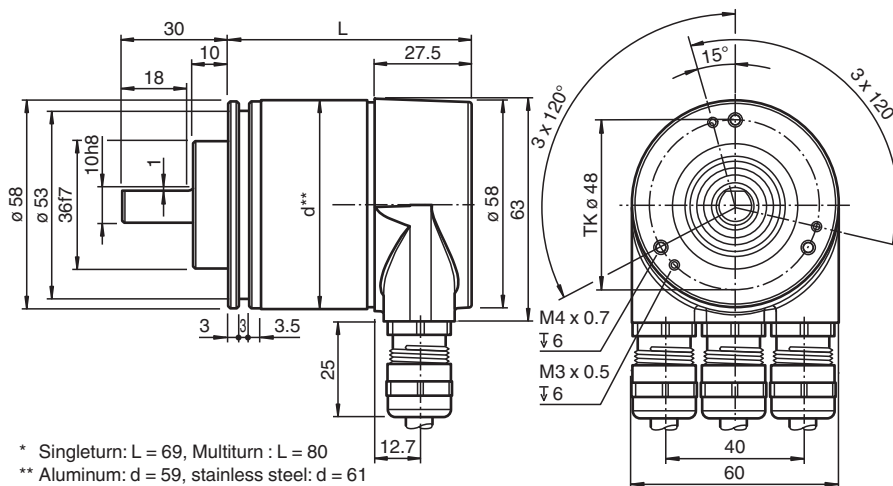

Release date: 2023-02-14 Date of issue: 2023-02-14 Filename: t49156_eng.pdf

Dimensions

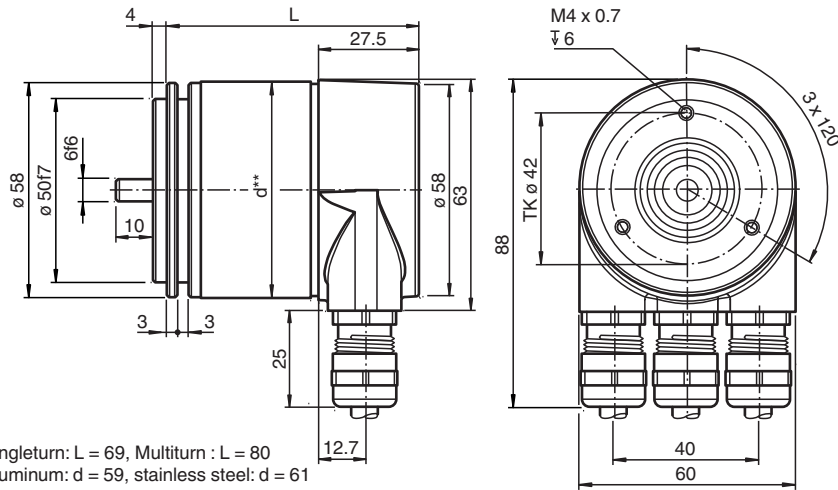

* Singleturn: L = 69, Multiturn : L = 80
 ** Aluminum: d = 59, stainless steel: d = 61

Technical Data















General specifications	
Detection type	photoelectric sampling
Device type	Singleturn absolute encoder
Electrical specifications	
Operating voltage	U_B 10 ... 30 V DC
No-load supply current	I_0 max. 230 mA at 10 V DC max. 100 mA at 24 V DC
Time delay before availability	t_v < 250 ms
Linearity	± 2 LSB at 16 Bit, ± 1 LSB at 13 Bit, $\pm 0,5$ LSB at 12 Bit
Output code	binary code
Code course (counting direction)	cw ascending (clockwise rotation, code course ascending) cw descending (clockwise rotation, code course descending)
Interface	
Interface type	DeviceNet
Resolution	
Single turn	up to 16 Bit
Overall resolution	up to 16 Bit
Transfer rate	max. 0.5 MBit/s
Connection	
Terminal compartment	in removable housing cover
Standard conformity	
Degree of protection	DIN EN 60529, IP65 IP66 (with shaft seal)
Climatic testing	DIN EN 60068-2-30 , no moisture condensation
Emitted interference	DIN EN 61000-6-4
Noise immunity	DIN EN 61000-6-2
Shock resistance	DIN EN 60068-2-27, 100 g, 6 ms
Vibration resistance	DIN EN 60068-2-6, 20 g, 10 ... 2000 Hz
Approvals and certificates	
UL approval	cULus Listed, General Purpose, Class 2 Power Source
Ambient conditions	
Operating temperature	-40 ... 85 °C (-40 ... 185 °F)
Storage temperature	-40 ... 85 °C (-40 ... 185 °F)
Mechanical specifications	
Material	
Combination 1	housing: powder coated aluminum flange: aluminum shaft: stainless steel

Release date: 2023-02-14 Date of issue: 2023-02-14 Filename: t49156_eng.pdf

Technical Data







Combination 2 (Inox)	housing: stainless steel flange: stainless steel shaft: stainless steel
Mass	approx. 550 g (combination 1) approx. 1000 g (combination 2)
Rotational speed	max. 12000 min ⁻¹
Moment of inertia	30 gcm ²
Starting torque	≤ 3 Ncm (version without shaft seal)
Shaft load	
Axial	40 N
Radial	110 N

Accessories

	9203	Angled flange
	AH 58-B1CA-2BW	Connection cover
	9310-3	Synchro clamping element
	9300	Mounting bracket for servo flange
	KW-10/10	Helical coupling
	KW-6/10	Helical coupling
	KW-6/6	Helical coupling
	KW-6/8	Helical coupling
	9401 10*10	Spring steel coupling
	9401 10*12	Spring steel coupling
	9401 6*10	Spring steel coupling
	9401 6*6	Spring steel coupling
	9402 6*6	Spring steel coupling
	9404 10*10	Spring disk coupling
	9404 6*6	Spring disk coupling

Release date: 2023-02-14 Date of issue: 2023-02-14 Filename: t49156_eng.pdf

Accessories

	9409 10*10	Bellows coupling
	9409 6*10	Bellows coupling
	9409 6*6	Bellows coupling
	9409 6*8	Bellows coupling
	9410 10*10	Precision coupling
	9410 6*6	Precision coupling
	MBT-36ALS	Spring-loaded mounting bracket with a diameter of 36 mm

Connection

Terminal	Cable	M12 x 1 Connector	Explanation
⊥	-	-	Ground connection for power supply
(+)	Red	2	Power supply
(-)	Black	3	Power supply
CG	-	1	CAN ground
CL	Blue	5	CAN low
CH	White	4	CAN high
CG	-	-	CAN ground
CL	Blue	-	CAN low
CH	White	-	CAN high

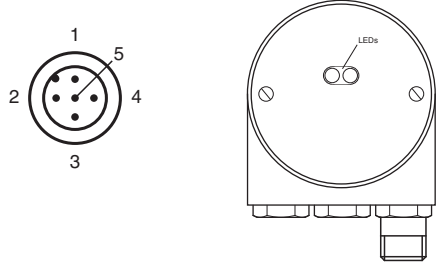

Configuration

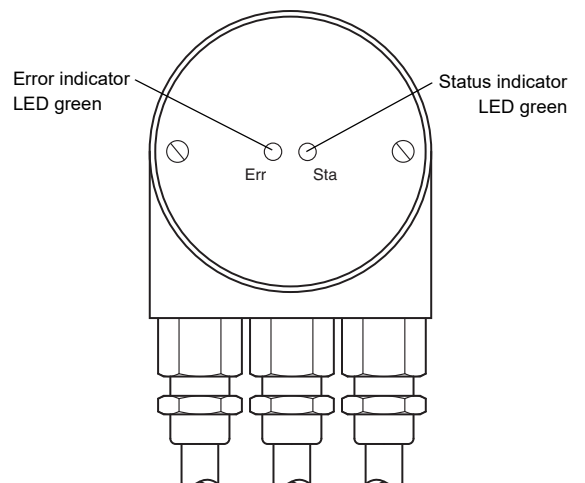
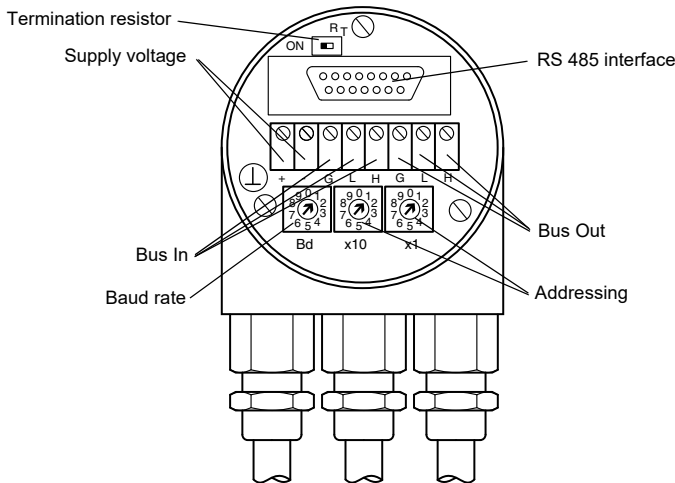

Adjusting the participant address

The participant address can be adjusted with the rotary switches. The address can be defined between 1 and 63, and may only be assigned once.

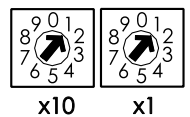

Adjusting the termination resistor

The terminating resistor R_T (121 Ω) can be connected to the circuit by means of the switch:

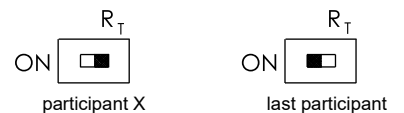

Release date: 2023-02-14 Date of issue: 2023-02-14 Filename: t49156_eng.pdf

Baud rate adjustment

Baud rate [kBit/s]	Switch position
125	0
250	1
500	2
125	3
reserved	4 ... 9

LED-indicators

LED red	LED green	Meaning
off	off	No voltage supply
off	on	Encoder ready, boot-up message not transmitted, yet. Possible reasons: - no further participant present - wrong baud rate - encoder in prepared status
flashing	on	Boot-up message transmitted, Device configuration possible.
on	on	Normal operation mode, encoder in operational status.

Parameterization**Programmable CAN operating modes**

Mode	Explanation
Polled mode	The connected host requests the current actual position value via a telegram. The absolute encoder reads in the current position, calculates all parameters that may have been set and then sends back the actual process value.
Cyclic mode	The absolute encoder sends the current process value depending on a programmable timer. This can cause the bus load to be reduced since the member on the network only sends a message after a specific amount of time without a prompt from the master.
Change of state mode	The absolute encoder monitors the current process value and transfers the current value by itself if there is any change in the value. This can cause the bus load to be reduced, since the member on the network only sends a message if there has been a change.

Programmable rotary encoder parameters

Parameter	Explanation
Operating parameter	The direction of rotation (complement) can be specified by parameter as the operating parameter. This parameter determines the direction of rotation in which the output code will be rising or descending.
Resolution per revolution	The "Resolution" parameter is used to program the rotary encoder so that a desired number of steps can be implemented in reference to a revolution.
Preset value	The preset value is the desired position value that must be achieved for a specific physical setting of the axis. The preset value parameter is used to set the actual position value to the desired actual process value.

Order code

D V S 5 8 - - - - R 0 B N - 0 0

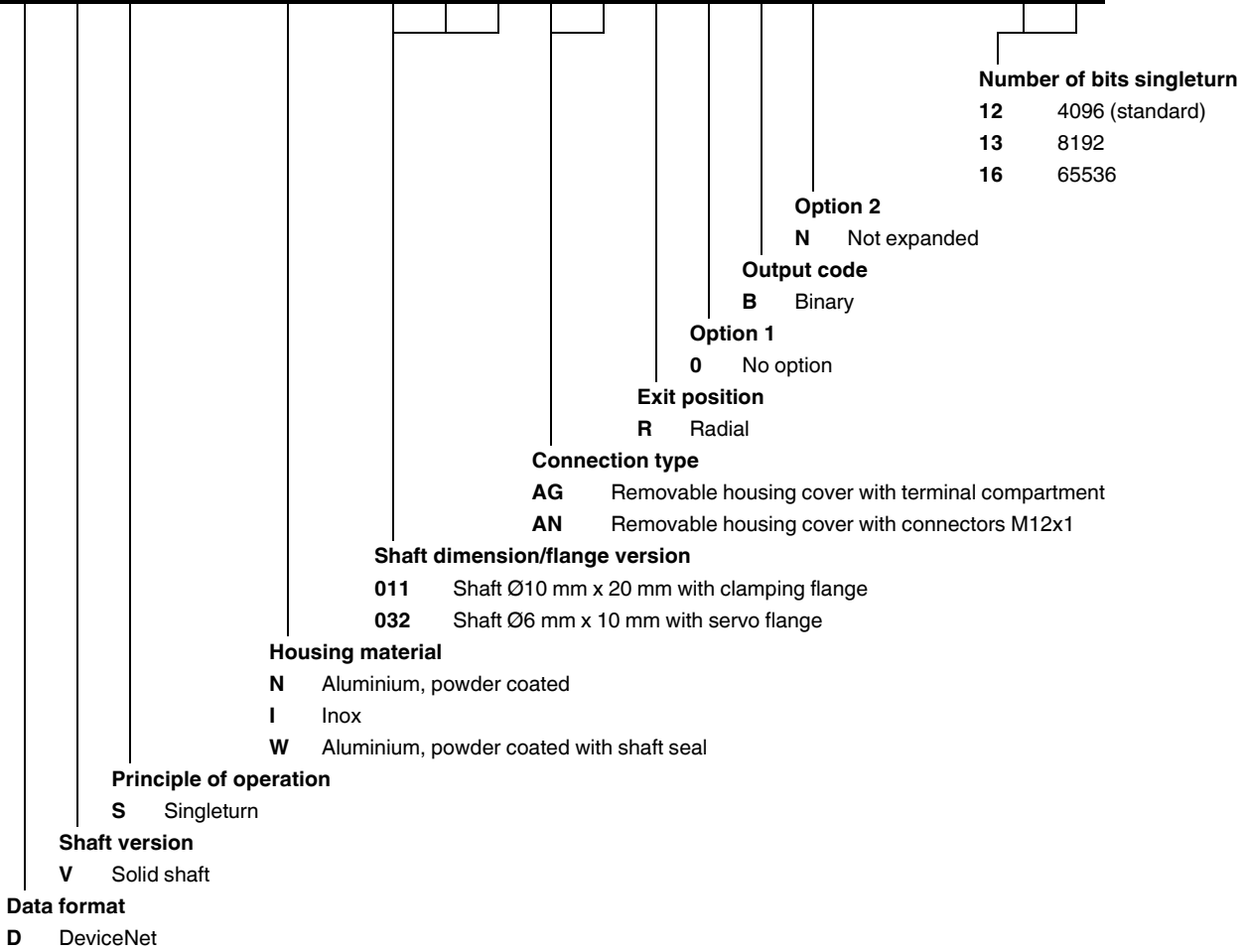

Release date: 2023-02-14 Date of issue: 2023-02-14 Filename: t49156_eng.pdf