



Singleturn absolute encoder

DSS58

- Industrial standard housing Ø58 mm
- 16 Bit singleturn
- Galvanically isolated DeviceNet interface
- Recessed hollow shaft



Function

In addition to the CANopen, PROFIBUS and AS-Interface rotary encoders, we have broadened our product line of bus-capable absolute encoders with the DSS58 for DeviceNet.

Absolute encoders deliver an absolute step value for each angle setting. All these values are represented by code samples of one or more code disks. The code disks are screened by an infrared LED and the bit obtained sample is detected by means of an optical array. Its signals are electronically amplified and are forwarded on to the interface for processing.

The absolute encoder has a maximum basic resolution of 65536 steps per revolution (16 Bits).

The integrated CAN bus interface of the absolute encoder supports all DeviceNet functions. The following operating modes can be programmed, and can selectively be turned on or off:

- Polled mode
- Cyclic mode
- Change of state mode

The absolute encoder is mounted directly onto the application shaft, without any coupling. Rotation of the absolute encoder is prevented by a torque rest.

Dimensions

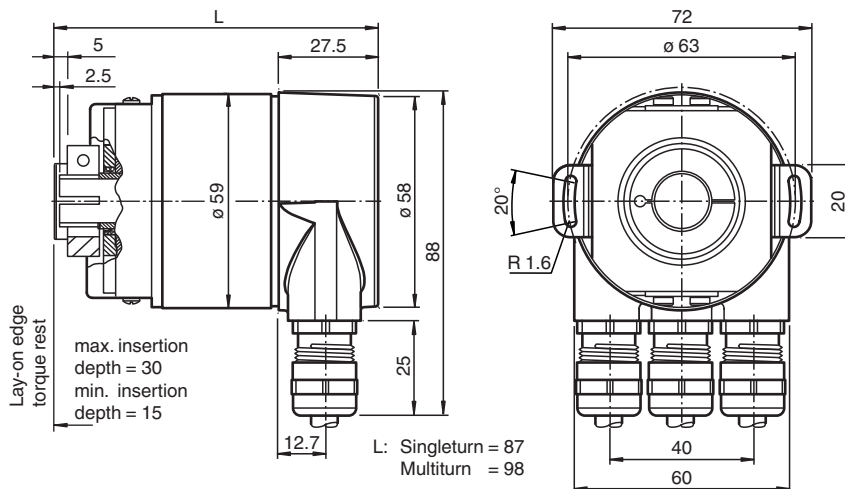

Technical Data



General specifications			
Detection type			photoelectric sampling
Device type			Singleturn absolute encoder
Electrical specifications			
Operating voltage	U _B		10 ... 30 V DC
No-load supply current	I ₀		max. 230 mA at 10 V DC max. 100 mA at 24 V DC

Release date: 2023-02-14 Date of issue: 2023-02-14 Filename: t49158_eng.pdf

Technical Data

Time delay before availability	t_v	< 250 ms
Linearity		± 2 LSB at 16 Bit, ± 1 LSB at 13 Bit, $\pm 0,5$ LSB at 12 Bit
Output code		binary code
Code course (counting direction)		cw ascending (clockwise rotation, code course ascending) cw descending (clockwise rotation, code course descending)
Interface		
Interface type		DeviceNet
Resolution		
Single turn		up to 16 Bit
Overall resolution		up to 16 Bit
Transfer rate		max. 0.5 MBit/s
Connection		
Terminal compartment		in removable housing cover
Standard conformity		
Degree of protection		DIN EN 60529, IP65 IP66 (with shaft seal)
Climatic testing		DIN EN 60068-2-30, no moisture condensation
Emitted interference		DIN EN 61000-6-4
Noise immunity		DIN EN 61000-6-2
Shock resistance		DIN EN 60068-2-27, 100 g, 6 ms
Vibration resistance		DIN EN 60068-2-6, 20 g, 10 ... 2000 Hz
Approvals and certificates		
UL approval		cULus Listed, General Purpose, Class 2 Power Source
Ambient conditions		
Operating temperature		-40 ... 85 °C (-40 ... 185 °F)
Storage temperature		-40 ... 85 °C (-40 ... 185 °F)
Mechanical specifications		
Material		
Combination 1		housing: powder coated aluminum flange: aluminum shaft: stainless steel
Combination 2 (Inox)		housing: stainless steel flange: stainless steel shaft: stainless steel
Mass		approx. 550 g (combination 1) approx. 1100 g (combination 2)
Rotational speed		max. 12000 min ⁻¹
Moment of inertia		30 gcm ²
Starting torque		≤ 3 Ncm (version without shaft seal)
Tightening torque, fastening screws		max. 1.8 Nm
Shaft load		
Angle offset		$\pm 0.9^\circ$
Axial offset		static: ± 0.3 mm, dynamic: ± 0.1 mm
Radial offset		static: ± 0.5 mm, dynamic: ± 0.2 mm

Accessories

	AH 58-B1CA-2BW	Connection cover
	ACC-PACK-ABS-_S_58 Ø15	Accessories set for Ø58 absolut rotary encoder with recessed hollow shaft 15 mm
	ACC-PACK-ABS-_S_58 Ø14	Accessories set for Ø58 absolut rotary encoder with recessed hollow shaft 14 mm

Accessories**ACC-PACK-ABS-_S_58
ø12**

Accessories set for Ø58 absolut rotary encoder with recessed hollow shaft 12 mm

**ACC-PACK-ABS-_S_58
ø10**

Accessories set for Ø58 absolut rotary encoder with recessed hollow shaft 10 mm

Connection

Terminal	Cable	M12 x 1 Connector	Explanation
⊥	-	-	Ground connection for power supply
(+)	Red	2	Power supply
(-)	Black	3	Power supply
CG	-	1	CAN ground
CL	Blue	5	CAN low
CH	White	4	CAN high
CG	-	-	CAN ground
CL	Blue	-	CAN low
CH	White	-	CAN high

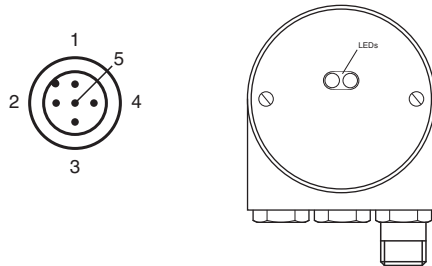

Configuration

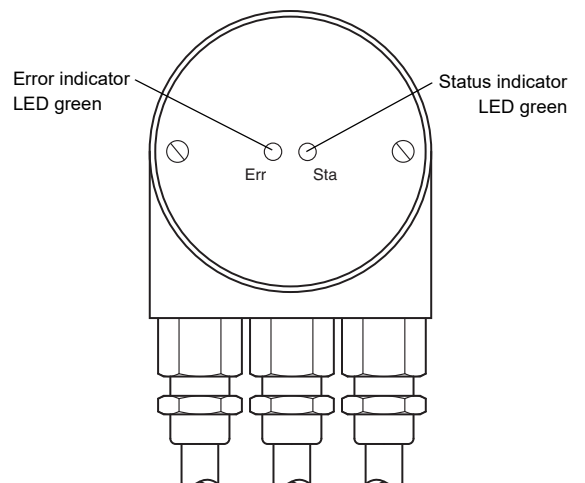
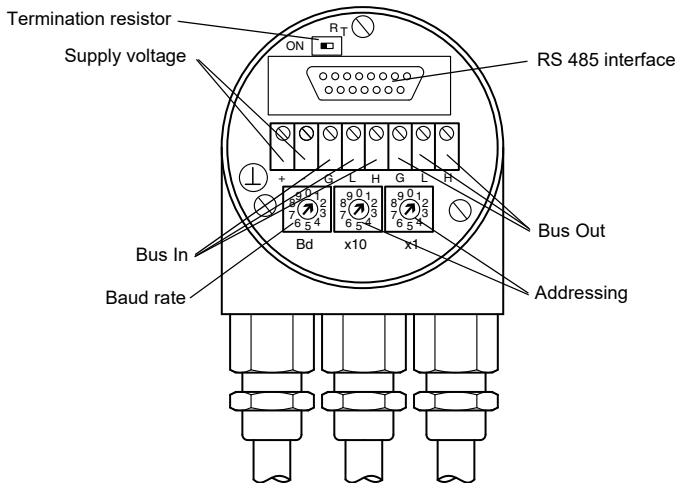

Adjusting the participant address

The participant address can be adjusted with the rotary switches. The address can be defined between 1 and 63, and may only be assigned once.

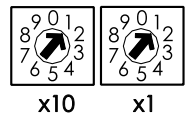

Adjusting the termination resistor

The terminating resistor R_T (121 Ω) can be connected to the circuit by means of the switch:

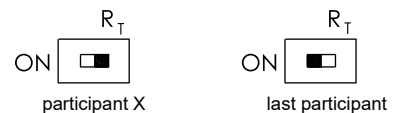

Release date: 2023-02-14 Date of issue: 2023-02-14 Filename: t49158_eng.pdf

Baud rate adjustment

Baud rate [kBit/s]	Switch position
125	0
250	1
500	2
125	3
reserved	4 ... 9

LED-indicators

LED red	LED green	Meaning
off	off	No voltage supply
off	on	Encoder ready, boot-up message not transmitted, yet. Possible reasons: - no further participant present - wrong baud rate - encoder in prepared status
flashing	on	Boot-up message transmitted, Device configuration possible.
on	on	Normal operation mode, encoder in operational status.

Parameterization**Programmable CAN operating modes**

Mode	Explanation
Polled mode	The connected host requests the current actual position value via a telegram. The absolute encoder reads in the current position, calculates all parameters that may have been set and then sends back the actual process value.
Cyclic mode	The absolute encoder sends the current process value depending on a programmable timer. This can cause the bus load to be reduced since the member on the network only sends a message after a specific amount of time without a prompt from the master.
Change of state mode	The absolute encoder monitors the current process value and transfers the current value by itself if there is any change in the value. This can cause the bus load to be reduced, since the member on the network only sends a message if there has been a change.

Programmable rotary encoder parameters

Parameter	Explanation
Operating parameter	The direction of rotation (complement) can be specified by parameter as the operating parameter. This parameter determines the direction of rotation in which the output code will be rising or descending.
Resolution per revolution	The "Resolution" parameter is used to program the rotary encoder so that a desired number of steps can be implemented in reference to a revolution.
Preset value	The preset value is the desired position value that must be achieved for a specific physical setting of the axis. The preset value parameter is used to set the actual position value to the desired actual process value.

Type Code

Order code

D S S 5 8 - - - - R 0 B N - 0 0

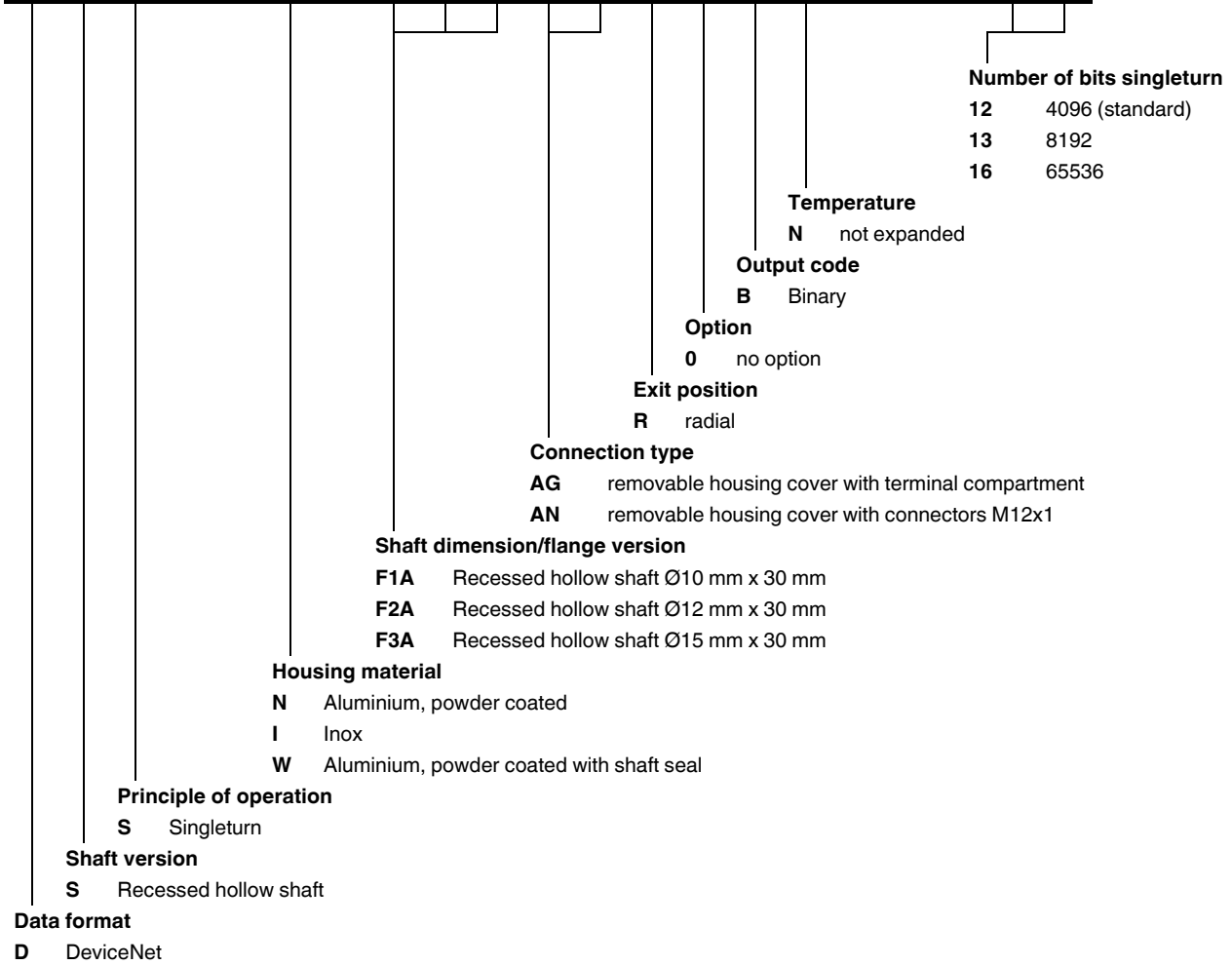

Release date: 2023-02-14 Date of issue: 2023-02-14 Filename: t49158_eng.pdf