



Singleturn absolute encoder CVS58

- Industrial standard housing Ø58 mm
- Servo or clamping flange
- 16 Bit singleturn
- Galvanically isolated CAN interface
- 2 limit switches
- 8 programmable cams
- Velocity and acceleration output
- Event triggered process data transfer



Function

Absolute encoders deliver an absolute step value for each angle setting. All these values are represented by code samples on one or more code disks which are sampled by a photoelectric array.

The absolute encoder has a maximum basic resolution of 65536 steps per revolution (16 Bits).

The integrated CAN bus interface of the absolute encoder supports all DeviceNet functions. The following operating modes can be programmed, and can selectively be turned on or off:

- Polled mode
- Cyclic mode
- Sync mode

The device is designed for shaft mounting and is available in servo flange or clamping flange design.

The bus electronics module is integrated into the removable housing cover. This makes it possible to mount or replace the new rotary encoders and the matching bus electronics separately during installation or service.

Dimensions

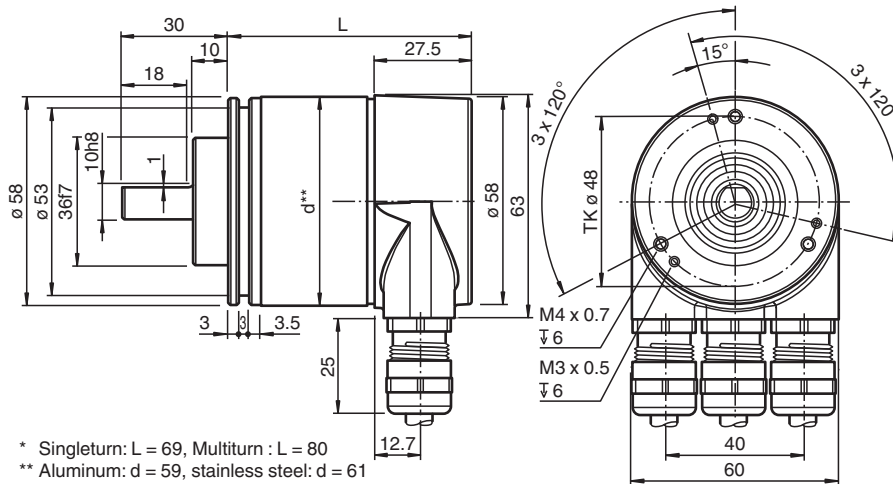

Dimensions

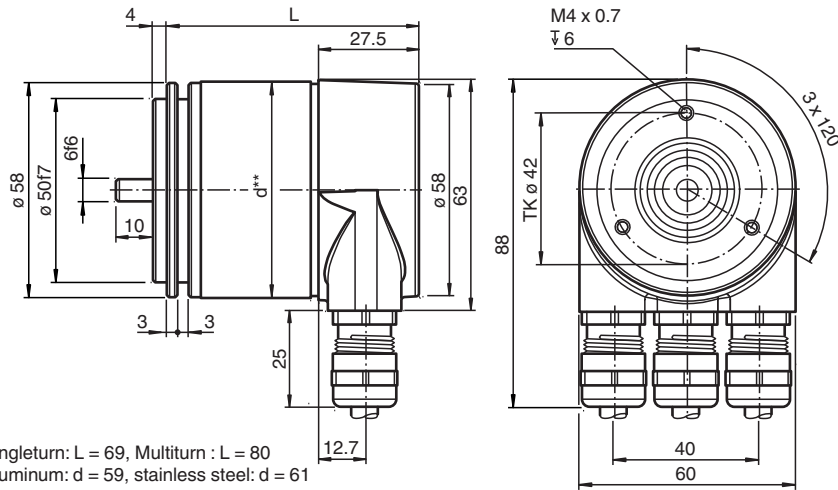

* Singleturn: L = 69, Multiturn : L = 80
 ** Aluminum: d = 59, stainless steel: d = 61

Technical Data















| | | | |
|-----------------------------------|-------|--|--|
| General specifications | | | |
| Detection type | | photoelectric sampling | |
| Device type | | Singleturn absolute encoder | |
| Electrical specifications | | | |
| Operating voltage | U_B | 10 ... 30 V DC | |
| No-load supply current | I_0 | max. 350 mA | |
| Time delay before availability | t_v | < 250 ms | |
| Linearity | | ± 2 LSB at 16 Bit, ± 1 LSB at 13 Bit, ± 0,5 LSB at 12 Bit | |
| Output code | | binary code | |
| Code course (counting direction) | | cw ascending (clockwise rotation, code course ascending) cw descending (clockwise rotation, code course descending) | |
| Interface | | | |
| Interface type | | CANopen | |
| Resolution | | | |
| Single turn | | up to 16 Bit | |
| Overall resolution | | up to 16 Bit | |
| Transfer rate | | max. 1 MBit/s | |
| Standard conformity | | communication profile: DS 301 Device profiles: DS 406 and DS 417 , programmable according to class 2 | |
| Connection | | | |
| Terminal compartment | | in removable housing cover | |
| Standard conformity | | | |
| Degree of protection | | DIN EN 60529, IP65 IP66 (with shaft seal) | |
| Climatic testing | | DIN EN 60068-2-30 , no moisture condensation | |
| Emitted interference | | EN 61000-6-4:2007 | |
| Noise immunity | | EN 61000-6-2:2005 | |
| Shock resistance | | DIN EN 60068-2-27, 100 g, 6 ms | |
| Vibration resistance | | DIN EN 60068-2-6, 20 g, 10 ... 2000 Hz | |
| Approvals and certificates | | | |
| UL approval | | cULus Listed, General Purpose, Class 2 Power Source | |
| Ambient conditions | | | |
| Operating temperature | | -40 ... 85 °C (-40 ... 185 °F) | |
| Storage temperature | | -40 ... 85 °C (-40 ... 185 °F) | |
| Mechanical specifications | | | |
| Material | | | |

Release date: 2023-02-14 Date of issue: 2023-02-14 Filename: t49160_eng.pdf

Technical Data







| | |
|----------------------|---|
| Combination 1 | housing: powder coated aluminum flange: aluminum shaft: stainless steel |
| Combination 2 (Inox) | housing: stainless steel flange: stainless steel shaft: stainless steel |
| Mass | approx. 550 g (combination 1) approx. 1100 g (combination 2) |
| Rotational speed | max. 12000 min ⁻¹ |
| Moment of inertia | 30 gcm ² |
| Starting torque | ≤ 3 Ncm (version without shaft seal) |
| Shaft load | |
| Axial | 40 N |
| Radial | 110 N |

Accessories

| | | |
|---|----------------|-----------------------------------|
|  | 9203 | Angled flange |
|  | AH 58-B1CA-2BW | Connection cover |
|  | 9310-3 | Synchro clamping element |
|  | 9300 | Mounting bracket for servo flange |
|  | KW-10/10 | Helical coupling |
|  | KW-6/10 | Helical coupling |
|  | KW-6/6 | Helical coupling |
|  | KW-6/8 | Helical coupling |
|  | 9401 10*10 | Spring steel coupling |
|  | 9401 10*12 | Spring steel coupling |
|  | 9401 6*10 | Spring steel coupling |
|  | 9401 6*6 | Spring steel coupling |
|  | 9402 6*6 | Spring steel coupling |
|  | 9404 10*10 | Spring disk coupling |
|  | 9404 6*6 | Spring disk coupling |

Release date: 2023-02-14 Date of issue: 2023-02-14 Filename: t49160_eng.pdf

Accessories

| | | |
|---|-------------------|---|
|  | 9409 10*10 | Bellows coupling |
|  | 9409 6*10 | Bellows coupling |
|  | 9409 6*6 | Bellows coupling |
|  | 9409 6*8 | Bellows coupling |
|  | 9410 10*10 | Precision coupling |
|  | 9410 6*6 | Precision coupling |
|  | MBT-36ALS | Spring-loaded mounting bracket with a diameter of 36 mm |

Connection

| Terminal | Cable | Explanation |
|----------|-------|------------------------------------|
| ⊥ | - | Ground connection for power supply |
| (+) | Red | Power supply |
| (-) | Black | Power supply |
| G | - | CAN ground |
| L | Blue | CAN low |
| H | White | CAN high |
| G | - | CAN ground |
| L | Blue | CAN low |
| H | White | CAN high |

Configuration

Indicating and operating elements

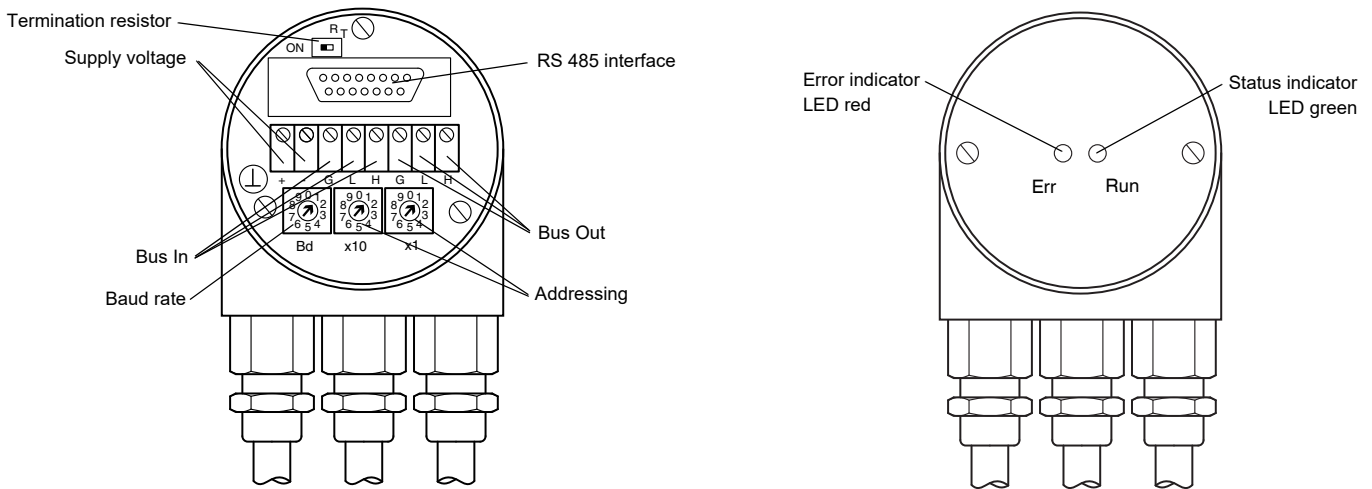

Adjusting the participant address

The participant address can be adjusted with the rotary switches. The address can be defined between 1 and 96, and may only be assigned once. The addresses 97 ... 99 are reserved.

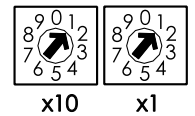

Adjusting the termination resistor

The terminating resistor R_T (121 Ω) can be connected to the circuit by means of the switch:

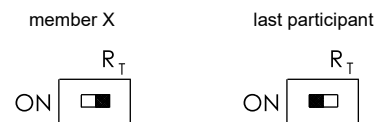

Baud rate adjustment

| Baud rate [kBit/s] | Switch position | Baud rate [kBit/s] | Switch position |
|--------------------|-----------------|--------------------------------------|-----------------|
| 20 | 0 | 500 | 5 |
| 50 | 1 | 800 | 6 |
| 100 | 2 | 1000 | 7 |
| 125 | 3 | reserved | 8 |
| 250 | 4 | set baud rate by SDO message and LSS | 9 |

Release date: 2023-02-14 Date of issue: 2023-02-14 Filename: t49160_eng.pdf

LED-indicators

| CAN Run (green) | State | Description |
|-----------------|-----------------------------|---|
| flickering | AutoBitrate / LSS | Auto-bitrate detection is in progress or LSS services are in progress |
| blinking | PREOPERATIONAL | Encoder is in state PREOPERATIONAL |
| single flash | STOPPED | Encoder is in state STOPPED |
| double flash | | reserved |
| triple flash | Program / Firmware download | a software download is running on the encoder |
| on | OPERATIONAL | the encoder is in state OPERATIONAL |

| Err (red) | State | Description |
|-----------------|-----------------------|--|
| off | no error | the encoder is in working condition |
| flickering | AutoBitrate / LSS | Auto-bitrate detection is in progress or LSS services are in progress |
| blinking | invalid configuration | general configuration error |
| single flash | Warning limit reached | at least one of the error counters of the CAN controller has reached or exceeded the warning level (too many error frames) |
| double flash | Error control event | a guard event (NMT-slave or NMT-master) or a heartbeat event (heartbeat consumer) has occurred |
| triple flash | Sync. error | the sync. message has not been received within the configured communication cycle period time out (see objekt 1006h) |
| quadruple flash | Error, event-timer | an expected PDO has not been received before the even-timer elapsed |
| on | Bus off | the CAN controller is bus off |

Parameterization

Programmable CAN operating modes

| Mode | Explanation |
|-------------|--|
| Polled mode | The connected host requests the current actual position value via a remote transmission request telegram. The absolute encoder reads in the current position, calculates all parameters that have been set and sends back the process actual value through the same CAN identifier. |
| Cyclic mode | The absolute encoder sends the current actual process value cyclically, without being prompted by the host. The cycle time can be programmed in milliseconds for values between 1 ms and 65536 ms. |
| Sync mode | After the sync telegram has been received by the host, the absolute encoder sends the current actual process value. If multiple nodes should respond to the sync telegram, the individual nodes report one after the other according to their CAN identifier. There is no programming of an offset time. The sync counter can be programmed so that the rotary encoder does not transmit until after a defined number of sync telegrams. |

Programmable rotary encoder parameters

| Parameter | Explanation |
|---------------------------|--|
| Operating parameter | The direction of rotation (complement) can be specified by parameter as the operating parameter. This parameter determines the direction of rotation in which the output code will ascend or descend. |
| Resolution per revolution | The "Resolution" parameter is used to program the rotary encoder so that a desired number of steps can be implemented in reference to one revolution. |
| Preset value | The preset value is the desired position value that must be achieved for a specific physical setting of the axis. The preset value parameter is used to set the actual position value to the desired actual process value. |
| 2 limit switches | A total of two positions can be programmed. The absolute encoder sets one bit to high state in the 32 Bit actual process value if a value falls outside the range between these two positions. |
| 8 cam switches | Up to 8 position values can be programmed as cams. By reaching these values bits in object 6300h Cam state register are set. |

Type Code

Release date: 2023-02-14 Date of issue: 2023-02-14 Filename: t49160_eng.pdf

Order code

C V S 5 8 - - - - R 0 B N - 0 0

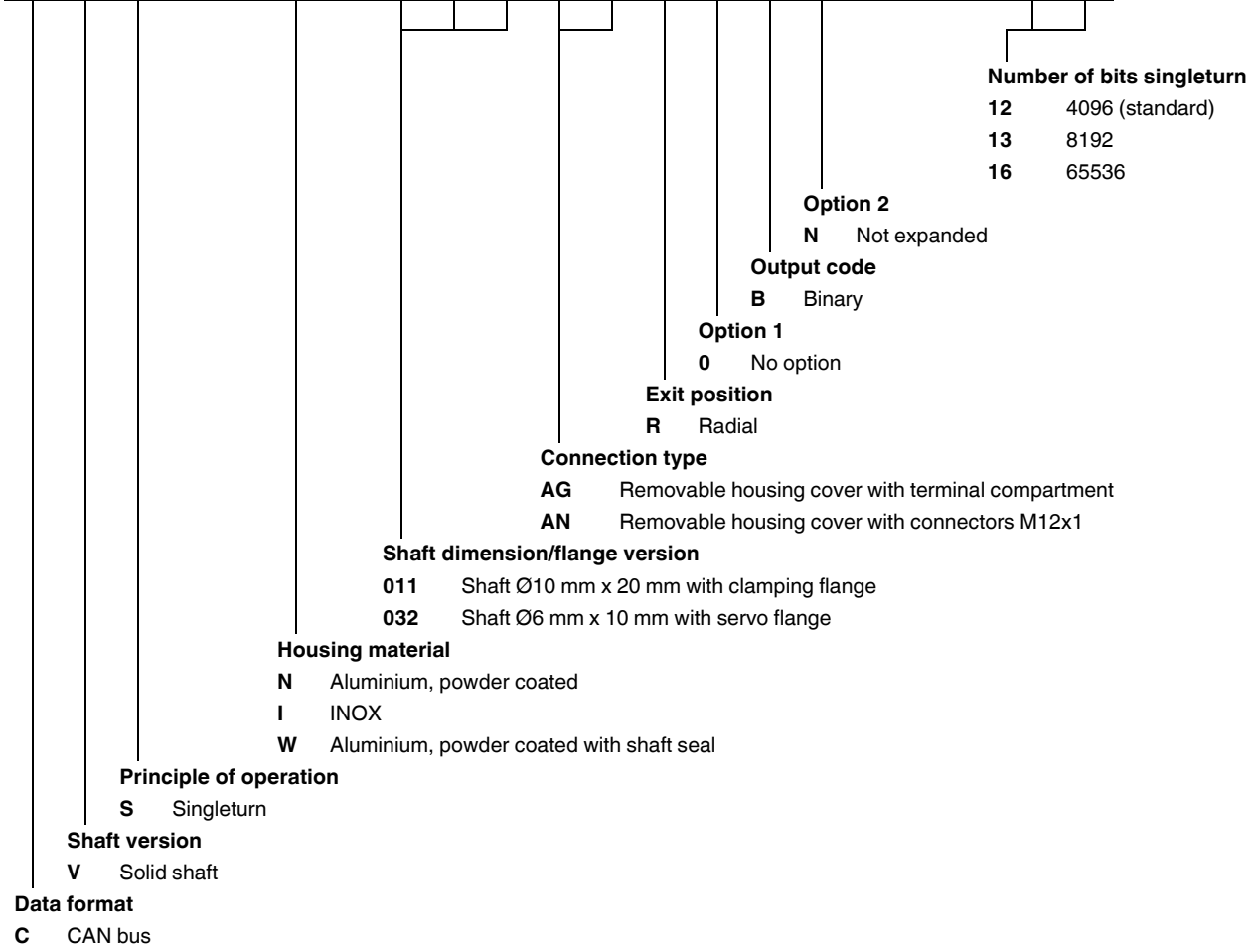

Release date: 2023-02-14 Date of issue: 2023-02-14 Filename: t49160_eng.pdf