



Singleturn absolute encoder AVS58-K

- Industrial standard housing $\varnothing 58$ mm
- 16 Bit singleturn
- Data transfer up to 2 MBaud
- Optically isolated RS 422 interface
- Servo or clamping flange
- Zero-set function electrically and by preset key



Function

This singleturn absolute encoder with modern fast technology transmits a position value corresponding to the shaft setting via the SSI interface (Synchronous Serial Interface). The resolution of the AVS58-K is maximum 65536 steps per revolution. The devices of the AVS58-K series are equipped with a microcontroller.

The control module sends a clock bundle to the absolute encoder to obtain position data. The rotary encoder then sends the position data synchronous to the cycles of the control module. It is possible to select the following items with function inputs the counting direction and the zero-set function (preset value).

Another feature of this absolute encoder is the built in preset key at the rear housing side. By means of this, the position value can be locally set to zero. For status and diagnosis indication furthermore it is equipped with 2 LEDs.

This singleturn absolute encoder is available either in clamp flange design with a shaft diameter of 10 mm x 20 mm or in a servo flange design with a shaft diameter of 6 mm x 10 mm.

The electrical connection is made by a 12-pin round plug connector. A version with a 1 m cable connector is also available.

Dimensions

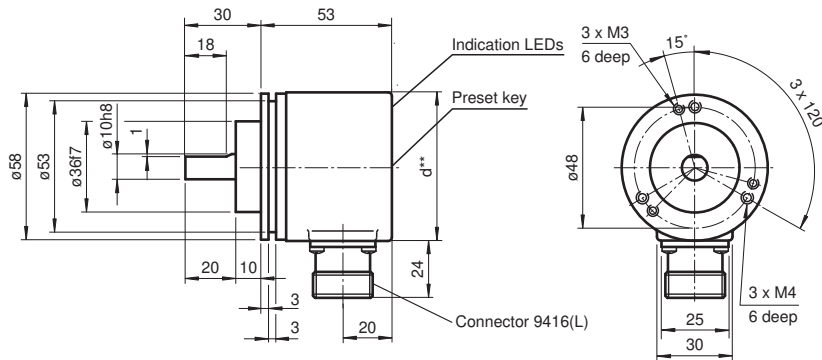

** Aluminium: d = 59, stainless steel: d = 61

Clamping flange

Dimensions

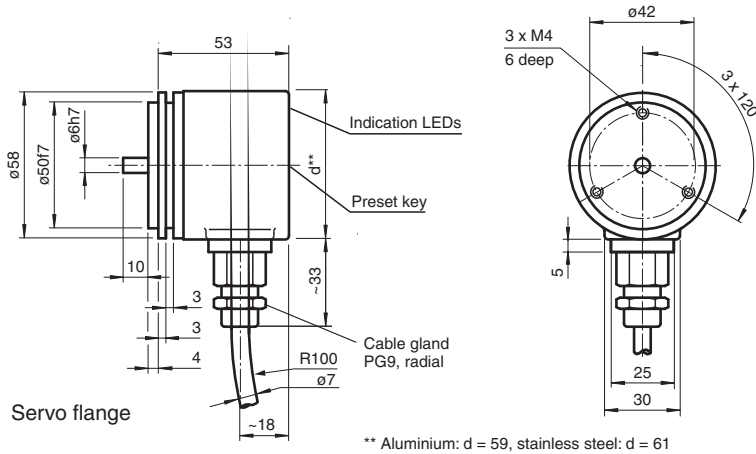
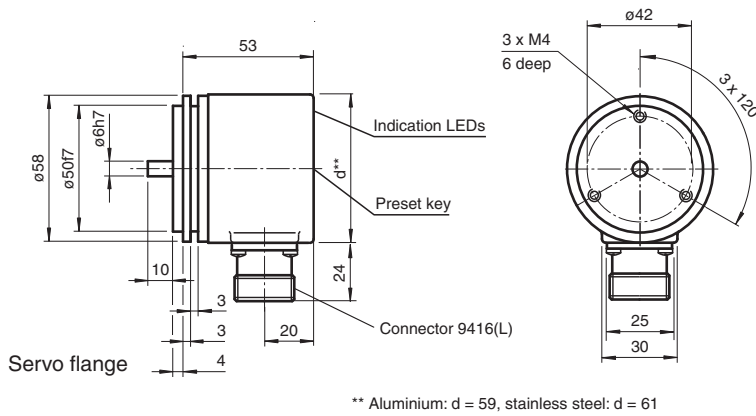
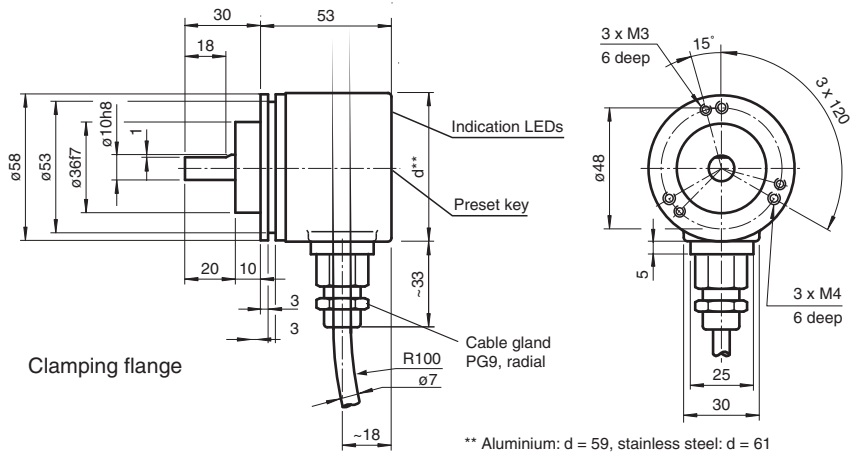

Technical Data

General specifications

Detection type	photoelectric sampling
Device type	Singleturn absolute encoder

Indicators/operating means

LED green	supply voltage/preset key pressed
LED red	internal diagnostic test failed

Electrical specifications

Operating voltage	U_B	4.5 ... 30 V DC
-------------------	-------	-----------------

Release date: 2023-02-14 Date of issue: 2023-02-14 Filename: t49172_eng.pdf

















Technical Data

Power consumption	P_0	$\leq 1 \text{ W}$
Time delay before availability	t_v	$< 250 \text{ ms}$
Linearity		$\pm 2 \text{ LSB at 16 Bit, } \pm 1 \text{ LSB at 13 Bit, } \pm 0,5 \text{ LSB at 12 Bit}$
Output code		Gray code, binary code
Code course (counting direction)		cw descending (clockwise rotation, code course descending)
Interface		
Interface type		SSI
Monoflop time		$20 \pm 10 \mu\text{s}$
Resolution		
Single turn		up to 16 Bit
Overall resolution		up to 16 Bit
Transfer rate		0.1 ... 2 MBit/s
Voltage drop		$U_B - 2.5 \text{ V}$
Standard conformity		RS 422
Input 1		
Input type		Selection of counting direction (cw/ccw)
Signal voltage		
High		4.5 ... 30 V or open input (cw ascending)
Low		0 ... 1 V (cw descending)
Input current		$< 6 \text{ mA}$
Switch-on delay		$< 10 \text{ ms}$
Input 2		
Input type		zero-set (PRESET 1)
Signal voltage		
High		4.5 ... 30 V
Low		0 ... 1 V or open input
Input current		$< 6 \text{ mA}$
Signal duration		min. 100 ms
Switch-on delay		$< 10 \text{ ms}$ after falling input flank
Connection		
Connector		type 9416 (M23), 12-pin, type 9416L (M23), 12-pin
Cable		$\varnothing 7 \text{ mm, } 6 \times 2 \times 0.14 \text{ mm}^2, 1 \text{ m}$
Standard conformity		
Degree of protection		DIN EN 60529, IP65 (without shaft seal) ; DIN EN 60529, IP66/IP67 (with shaft seal)
Climatic testing		DIN EN 60068-2-3, no moisture condensation
Emitted interference		DIN EN 61000-6-4
Noise immunity		DIN EN 61000-6-2
Shock resistance		DIN EN 60068-2-27, 100 g, 6 ms
Vibration resistance		DIN EN 60068-2-6, 20 g, 10 ... 2000 Hz
Approvals and certificates		
UL approval		cULus Listed, General Purpose, Class 2 Power Source
Ambient conditions		
Operating temperature		$-40 \dots 85 \text{ }^\circ\text{C}$ ($-40 \dots 185 \text{ }^\circ\text{F}$)
Storage temperature		$-40 \dots 85 \text{ }^\circ\text{C}$ ($-40 \dots 185 \text{ }^\circ\text{F}$)
Mechanical specifications		
Material		
Combination 1		housing: powder coated aluminum flange: aluminum shaft: stainless steel
Combination 2 (Inox)		housing: stainless steel flange: stainless steel shaft: stainless steel
Mass		approx. 460 g (combination 1) approx. 800 g (combination 2)
Rotational speed		max. 12000 min^{-1}

Technical Data







Moment of inertia	$\leq 30 \text{ gcm}^2$
Starting torque	$< 3 \text{ Ncm}$ (version without shaft seal)
Shaft load	
Axial	40 N
Radial	110 N

Accessories

	9203	Angled flange
	9416	Female cordset
	9310-3	Synchro clamping element
	9300	Mounting bracket for servo flange
	KW-10/10	Helical coupling
	KW-6/10	Helical coupling
	KW-6/6	Helical coupling
	KW-6/8	Helical coupling
	9401 10*10	Spring steel coupling
	9401 10*12	Spring steel coupling
	9401 6*10	Spring steel coupling
	9401 6*6	Spring steel coupling
	9402 6*6	Spring steel coupling
	9404 10*10	Spring disk coupling
	9404 6*6	Spring disk coupling
	9409 10*10	Bellows coupling
	9409 6*10	Bellows coupling

Release date: 2023-02-14 Date of issue: 2023-02-14 Filename: t49172_eng.pdf

Accessories

	9409 6*6	Bellows coupling
	9409 6*8	Bellows coupling
	9410 10*10	Precision coupling
	9410 6*6	Precision coupling
	MBT-36ALS	Spring-loaded mounting bracket with a diameter of 36 mm
	9416-*M-12P-AVM	Female cordset, M23, 12-pin, PVC cable, 8-core

Connection

Signal	Cable Ø7 mm, 12-core	Connector 9416, 12-pin	Connector 9416L, 12-pin	Explanation
GND (encoder)	White	1	1	Power supply
U _b (encoder)	Brown	2	8	Power supply
Clock (+)	Green	3	3	Positive cycle line
Clock (-)	Yellow	4	11	Negative cycle line
Data (+)	Grey	5	2	Positive transmission data
Data (-)	Pink	6	10	Negative transmission data
Reserved	Blue	7	12	Not wired, reserved
V/R	Red	8	5	Input for selection of counting direction
PRESET 1	Black	9	9	zero-setting input
Reserved	Violet	10	4	Not wired, reserved
Reserved	Grey/Pink	11	6	Not wired, reserved
Reserved	Red/Blue	12	7	Not wired, reserved

--	--

Interface

Description

The Synchronous Serial Interface was specially developed for transferring the output data of an absolute encoder to a control device. The control module sends a clock bundle and the absolute encoder responds with the position value. Thus only 4 lines are required for the clock and data, no matter what the resolution of the rotary encoder is. The RS 422 interface is optically isolated from the power supply.

SSI signal course Standard

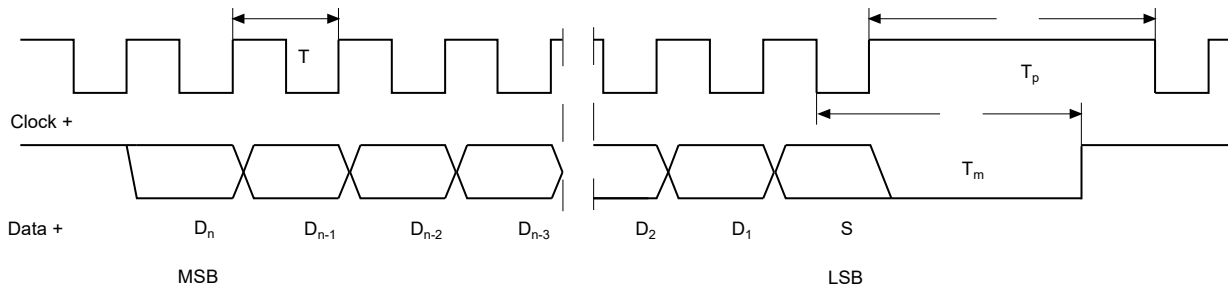

- | | | | |
|--|-----------------------|------------------|--|
| D ₁ , ..., D _n : | Position data | T = 1/f: | Duration of period of clock signal ≤ 1 MHz |
| S: | Special bit | T _m : | Monoflop time 10 μs ... 30 μs |
| MSB: | Most significant bit | T _p : | Clock pause ≥ monoflop time (T _p ≥ T _m) |
| LSB: | Least significant bit | | |

SSI output format Standard

- At idle status signal lines "Data +" and "Clock +" are at high level (5 V).
- The first time the clock signal switches from high to low, the data transfer in which the current information (position data (D_n) and special bit (S)) is stored in the encoder is introduced.
- The highest order bit (MSB) is applied to the serial data output of the encoder with the first rising pulse edge.
- The next successive lower order bit is transferred with each following rising pulse edge.
- After the lowest order bit (LSB) has been transferred the data line switches to low until the monoflop time T_m has expired.
- No subsequent data transfer can be started until the data line switches to high again or the time for the clock pause T_p has expired.
- After the clock sequence is complete, the monoflop time T_m is triggered with the last falling pulse edge.
- The monoflop time T_m determines the lowest transmission frequency.

SSI output format ring slide operation (multiple transmission)

- In ring slide operation, multiple transmission of the same data word over the SSI interface makes it possible to offer the possibility of detecting transmission errors.
- In multiple transmission, 25 bits are transferred per data word in standard format.

Release date: 2023-02-14 Date of issue: 2023-02-14 Filename: t49172_eng.pdf

- If the clock change is not interrupted after the last falling pulse edge, ring slide operation automatically becomes active. This means that the information that was stored at the time of the first clock change is generated again.
- After the first transmission, the 26th pulse controls data repetition. If the 26th pulse follows after an amount of time greater than the monoflop time T_m , a new current data word will be transmitted with the following pulses.



If the pulse line is exchanged, the data word is generated offset. Ring slide operation is possible up to max. 13 bits.

Block diagram

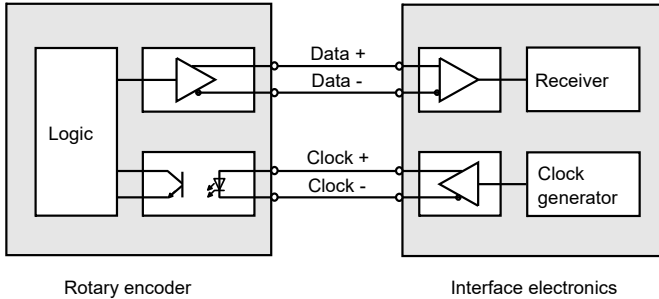

Line length

Line length in m	Baudrate in kHz
< 50	< 400
< 100	< 300
< 200	< 200
< 400	< 100

Operation

Inputs

Input for selection of counting direction (V/R)

Level	counting direction by cw revolution (with view onto the shaft)	Input counting direction (V/R)
High (input open or connected to +UB)	ascending	
Low (Input connected to GND)	descending	

Zero-set input (Preset)

Level	Funktion	Zero-set input (Preset)
Low (input open or connected to GND)	Output position value	
High (Input connected to +UB or $U_e > 4,5\text{ V}$)	Activation with falling edge (min. 100 ms)	

Indicators/operation means

Preset key	Manually zero setting of the position value.	
LED green	<ul style="list-style-type: none"> • Lights up with supplied encoder • Goes off while preset key is pressed 	
LED red	Alarm/error indication <ul style="list-style-type: none"> • pre-fault indication (data output ist continued) • internal memory error (all data bits are set to high level permanently) 	

Type Code

Release date: 2023-02-14 Date of issue: 2023-02-14 Filename: t49172_eng.pdf

Order code

A	V	S	5	8	-						R	K			N	-	0	0		
---	---	---	---	---	---	--	--	--	--	--	---	---	--	--	---	---	---	---	--	--

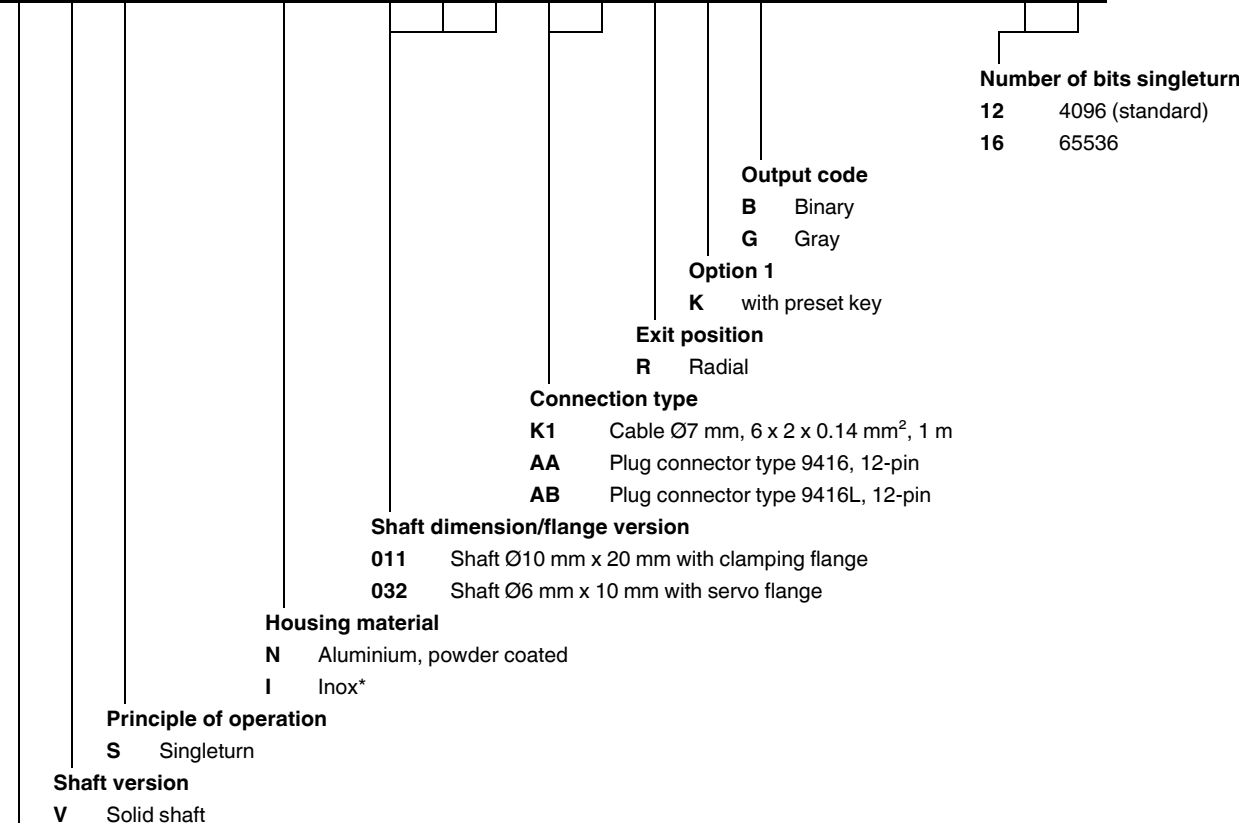

Number of bits singleturn
 12 4096 (standard)
 16 65536

Output code
 B Binary
 G Gray

Option 1
 K with preset key

Exit position
 R Radial

Connection type
 K1 Cable Ø7 mm, 6 x 2 x 0.14 mm², 1 m
 AA Plug connector type 9416, 12-pin
 AB Plug connector type 9416L, 12-pin

Shaft dimension/flange version
 011 Shaft Ø10 mm x 20 mm with clamping flange
 032 Shaft Ø6 mm x 10 mm with servo flange

Housing material
 N Aluminium, powder coated
 I Inox*

Principle of operation
 S Singleturn

Shaft version
 V Solid shaft

Data format
 A SSI (Synchronous Serial Interface)

*Housing material I only available with plug connector types.

Release date: 2023-02-14 Date of issue: 2023-02-14 Filename: t49172_eng.pdf